

BMT Series - Aluminum frame three phase low voltage electric motor

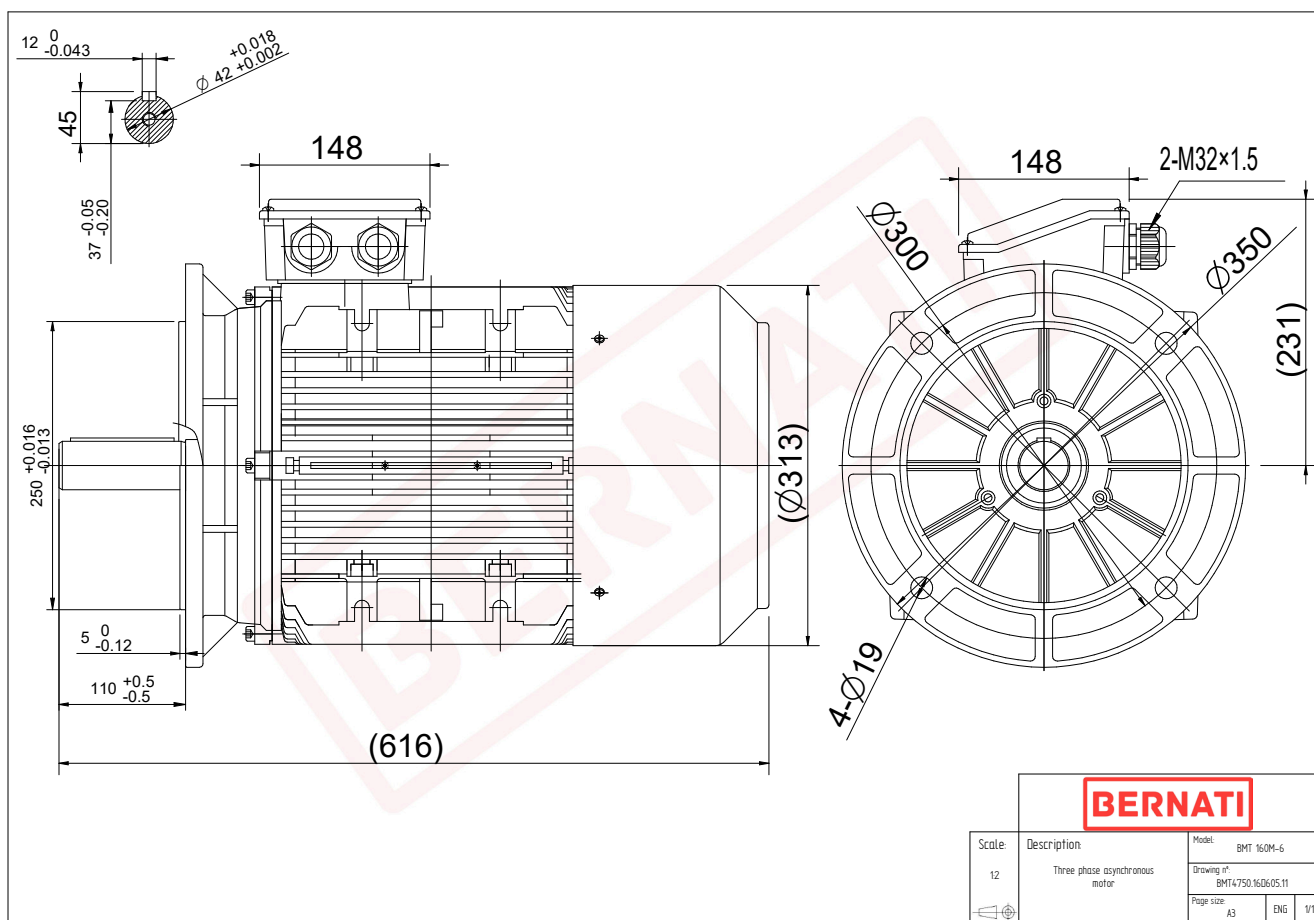

BMT	
Product Code	BMT4750.16D605.11
Motor Type/Frame	BMT 160M-6
Mounting	IM B5
Efficiency Class	IE4
Output Power (kW)	7.50
Speed (rpm)	980
Tension (V)	230/400
Frequency (Hz)	50
Current (A)	15.40
Power factor (Cos Ø)	0.80
Poles	6
Insulation Class	F
IP Class	IP55
50% Efficiency	90.3
75% Efficiency	91.5
100% Efficiency	91.3
Torque (Nm)	76.20
Tstart / Tnominal	3.30
Istart / Inominal	8.50
Tmax / Tnominal	1.80
Noise (dB)	68
PTC Thermistor	PTC 130
Weight (Kg)	92
DE Bearing	6309 2RZ C3
NDE Bearing	6209 2RZ C3