

BMT Series - Aluminum frame three phase low voltage electric motor

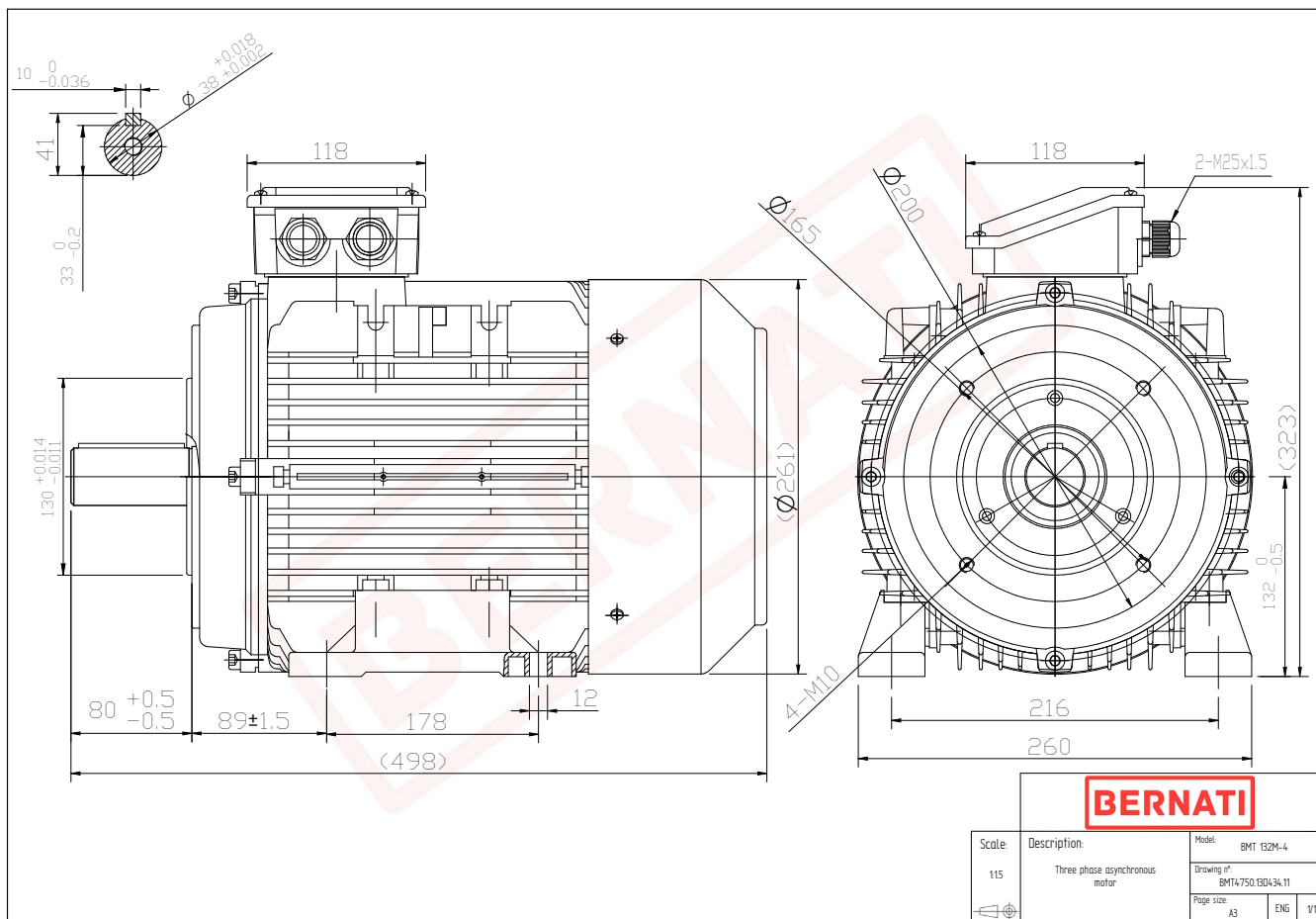

BMT

Product Code	BMT4750.13D434.11
Motor Type/Frame	BMT 132M-4
Mounting	IM B3/B14
Efficiency Class	IE4
Output Power (kW)	7.50
Speed (rpm)	1470
Tension (V)	230/400
Frequency (Hz)	50
Current (A)	13.90
Power factor (Cos Ø)	0.80
Poles	4
Insulation Class	F
IP Class	IP55
50% Efficiency	92.2
75% Efficiency	92.8
100% Efficiency	92.6
Torque (Nm)	50.80
Tstart / Tnominal	4.40
Istart / Inominal	10.20
Tmax / Tnominal	2.20
Noise (dB)	71
PTC Thermistor	PTC 130
Weight (Kg)	74
DE Bearing	6308 2RZ C3
NDE Bearing	6208 2RZ C3