

BMT Series - Aluminum frame three phase low voltage electric motor

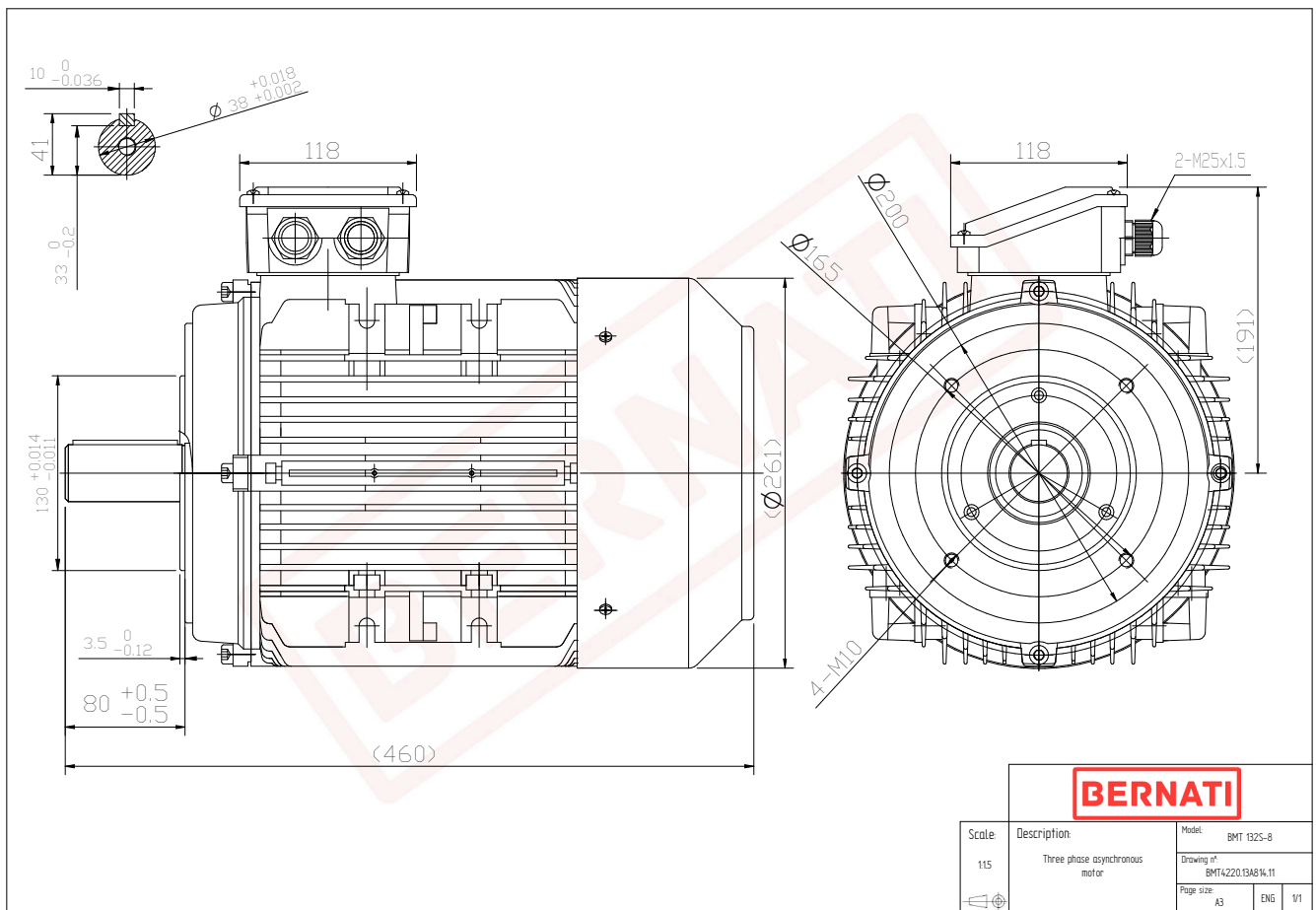

BMT	
Product Code	BMT4220.13A814.11
Motor Type/Frame	BMT 132S-8
Mounting	IM B14
Efficiency Class	IE4
Output Power (kW)	2.20
Speed (rpm)	725
Tension (V)	230/400
Frequency (Hz)	50
Current (A)	5.90
Power factor (Cos Ø)	0.60
Poles	8
Insulation Class	F
IP Class	IP55
50% Efficiency	82.5
75% Efficiency	85.5
100% Efficiency	84.5
Torque (Nm)	30.20
Tstart / Tnominal	2.30
Istart / Inominal	5.60
Tmax / Tnominal	2.00
Noise (dB)	64
PTC Thermistor	PTC 130
Weight (Kg)	50
DE Bearing	6308 2RZ C3
NDE Bearing	6208 2RZ C3