

Technical Datasheet

BERNATI

BMT Series - Aluminum frame three phase low voltage electric motor

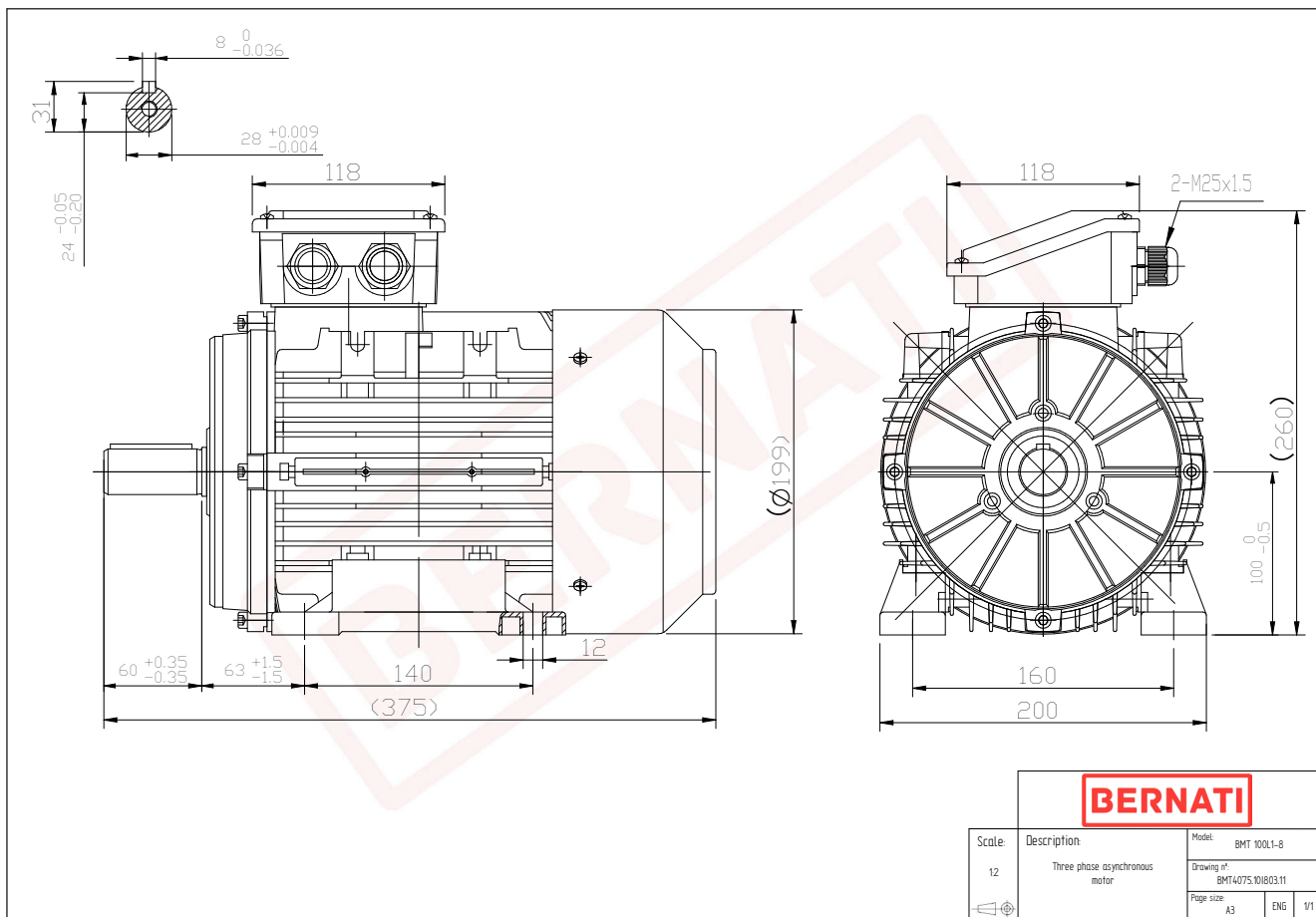

BMT	
Product Code	BMT4075.10I803.11
Motor Type/Frame	BMT 100L1-8
Mounting	IM B3
Efficiency Class	IE4
Output Power (kW)	0.75
Speed (rpm)	710
Tension (V)	230/400
Frequency (Hz)	50
Current (A)	2.20
Power factor (Cos Ø)	0.60
Poles	8
Insulation Class	F
IP Class	IP55
50% Efficiency	74.4
75% Efficiency	77.9
100% Efficiency	78.4
Torque (Nm)	10.50
Tstart / Tnominal	2.10
Istart / Inominal	4.30
Tmax / Tnominal	2.10
Noise (dB)	59
PTC Thermistor	PTC 130
Weight (Kg)	21
DE Bearing	6206 2RZ C3
NDE Bearing	6206 2RZ C3