

Technical Datasheet

BERNATI

BMT Series - Aluminum frame three phase low voltage electric motor

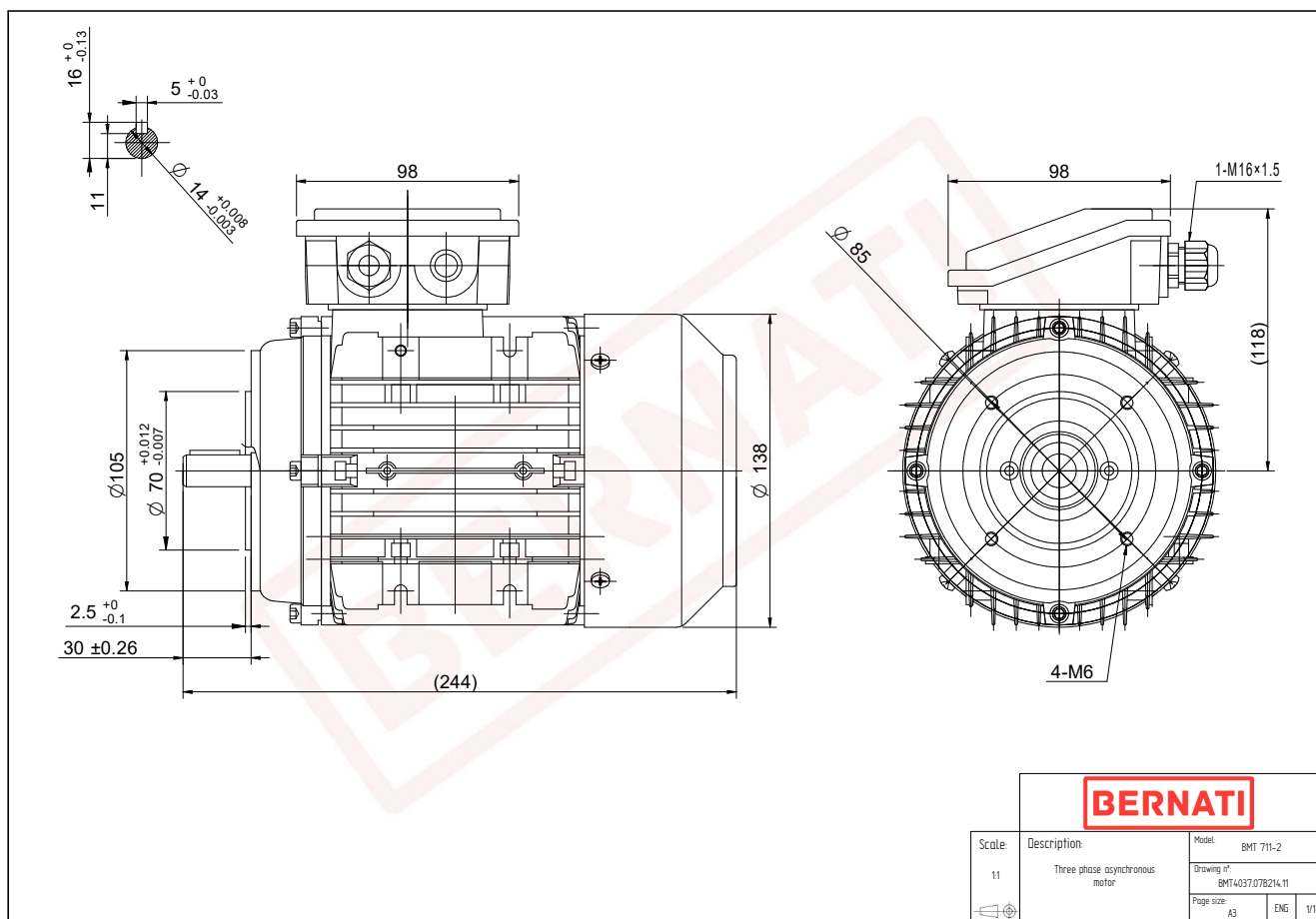

BMT	
Product Code	BMT4037.07B214.11
Motor Type/Frame	BMT 711-2
Mounting	IM B14
Efficiency Class	IE4
Output Power (kW)	0.37
Speed (rpm)	2890
Tension (V)	230/400
Frequency (Hz)	50
Current (A)	0.90
Power factor (Cos Ø)	0.80
Poles	2
Insulation Class	F
IP Class	IP55
50% Efficiency	73.4
75% Efficiency	77.3
100% Efficiency	78.1
Torque (Nm)	1.30
Tstart / Tnominal	2.80
Istart / Inominal	6.70
Tmax / Tnominal	3.30
Noise (dB)	64
PTC Thermistor	PTC 130
Weight (Kg)	6
DE Bearing	6202 2RZ C3
NDE Bearing	6202 2RZ C3