

Technical Datasheet

BERNATI

BMT Series - Aluminum frame three phase low voltage electric motor

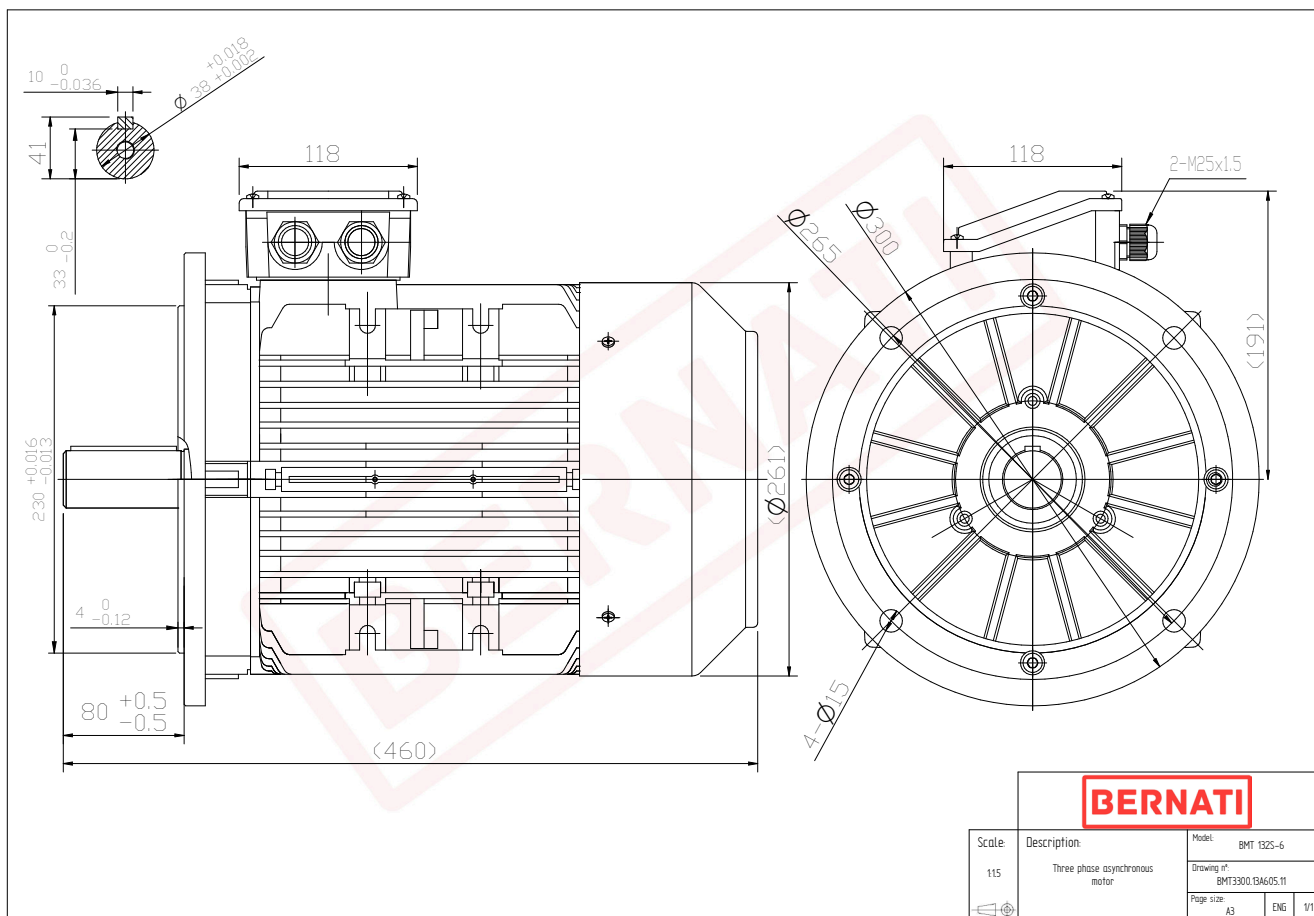

BMT	
Product Code	BMT3300.13A605.11
Motor Type/Frame	BMT 132S-6
Mounting	IM B5
Efficiency Class	IE3
Output Power (kW)	3.00
Speed (rpm)	965
Tension (V)	230/400
Frequency (Hz)	50
Current (A)	6.84
Power factor (Cos Ø)	0.74
Poles	6
Insulation Class	F
IP Class	IP55
50% Efficiency	85.1
75% Efficiency	86.0
100% Efficiency	85.6
Torque (Nm)	29.69
Tstart / Tnominal	2.00
Istart / Inominal	6.00
Tmax / Tnominal	2.70
Noise (dB)	64
PTC Thermistor	PTC 130
Weight (Kg)	39
DE Bearing	6308 2RZ C3
NDE Bearing	6208 2RZ C3