

Technical Datasheet

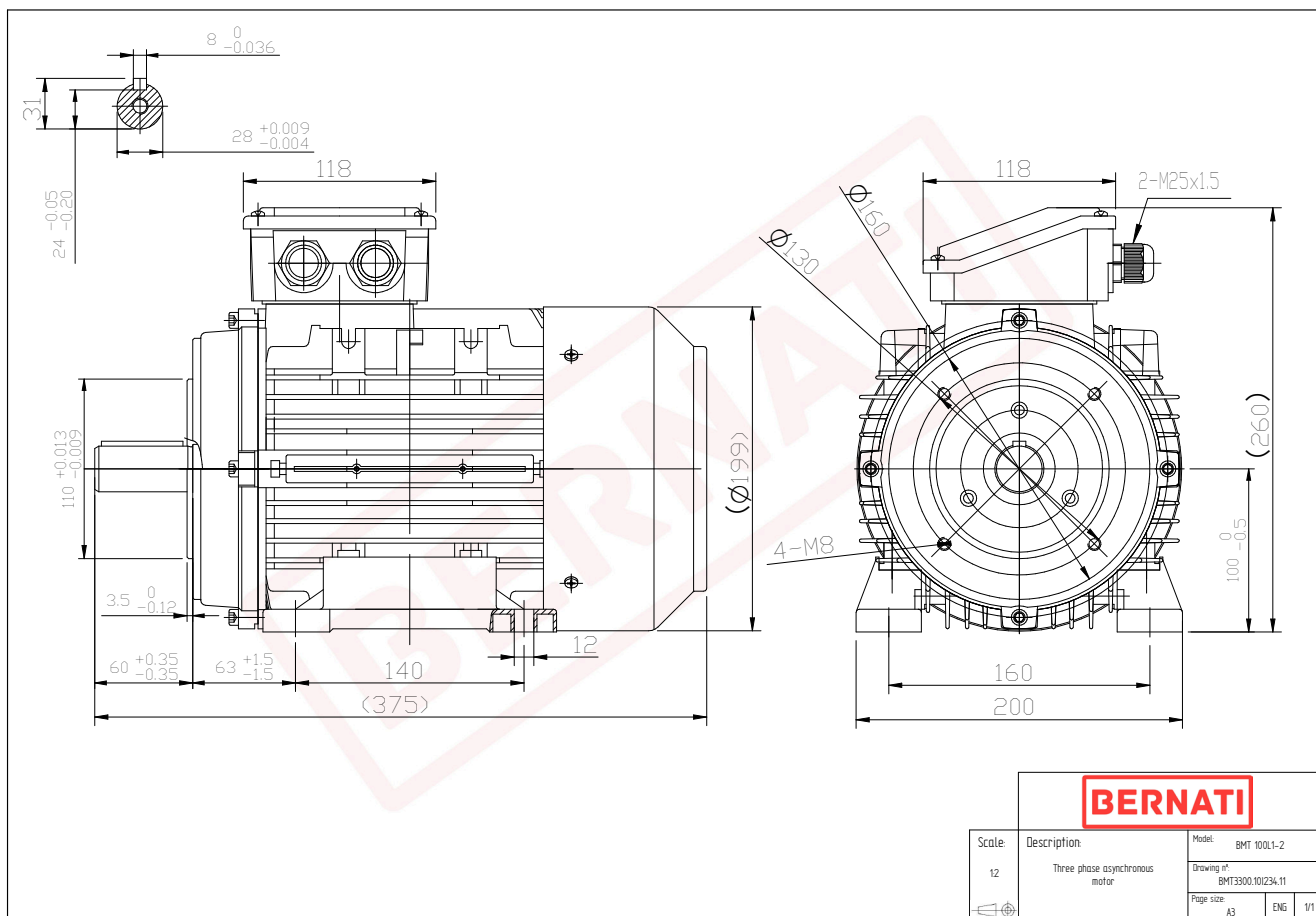

BMT Series - Aluminum frame three phase low voltage electric motor



BMT

Product Code	BMT3300.10I234.11
Motor Type/Frame	BMT 100L1-2
Mounting	IM B3/B14
Efficiency Class	IE3
Output Power (kW)	3.00
Speed (rpm)	2910
Tension (V)	230/400
Frequency (Hz)	50
Current (A)	5.59
Power factor (Cos Ø)	0.89
Poles	2
Insulation Class	F
IP Class	IP55
50% Efficiency	86.3
75% Efficiency	87.5
100% Efficiency	87.1
Torque (Nm)	9.85
Tstart / Tnominal	3.20
Istart / Inominal	9.40
Tmax / Tnominal	3.60
Noise (dB)	76
PTC Thermistor	PTC 130
Weight (Kg)	24
DE Bearing	6206 2RZ C3
NDE Bearing	6206 2RZ C3