

Technical Datasheet

BERNATI

BMM Series - Aluminum frame single phase electric motor

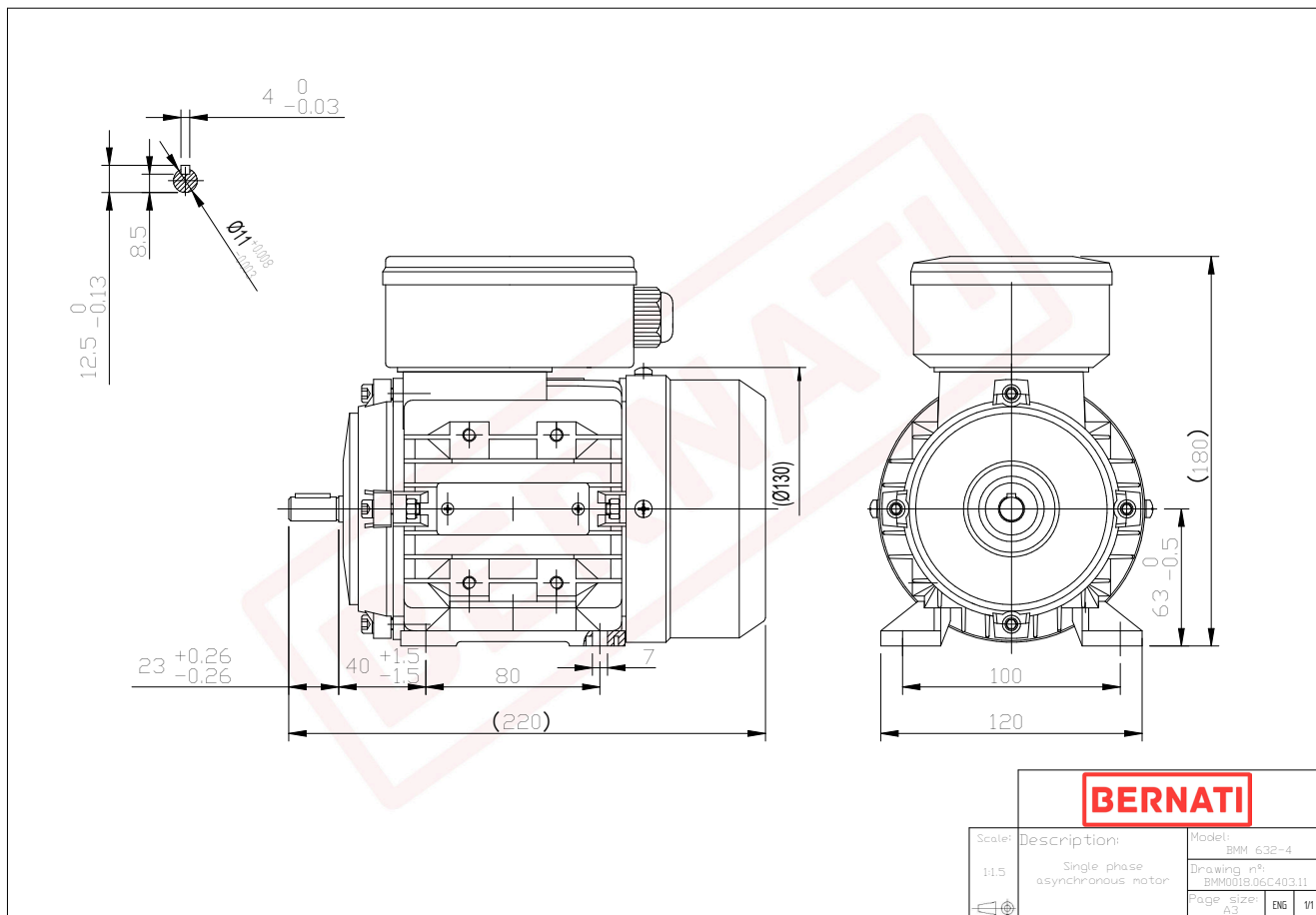

BMM

Product Code	BMM0018.06C403.11
Motor Type/Frame	BMM 632-4
Mounting	IM B3
Output Power (kW)	0.18
Speed (rpm)	1380
Tension (V)	230
Frequency (Hz)	50
Current (A)	1.40
Power factor (Cos Ø)	1.00
Poles	4
Insulation Class	F
IP Class	IP55
100% Efficiency	59.0
Torque (Nm)	1.30
Tstart / Tnominal	0.60
Istart / Inominal	2.50
Tmax / Tnominal	1.70
Noise (dB)	65
PTC Thermistor	N/A
Weight (Kg)	5
DE Bearing	6201 2RZ C3
NDE Bearing	6201 2RZ C3