

Technical Datasheet

BERNATI

BMM Series - Aluminum frame single phase electric motor

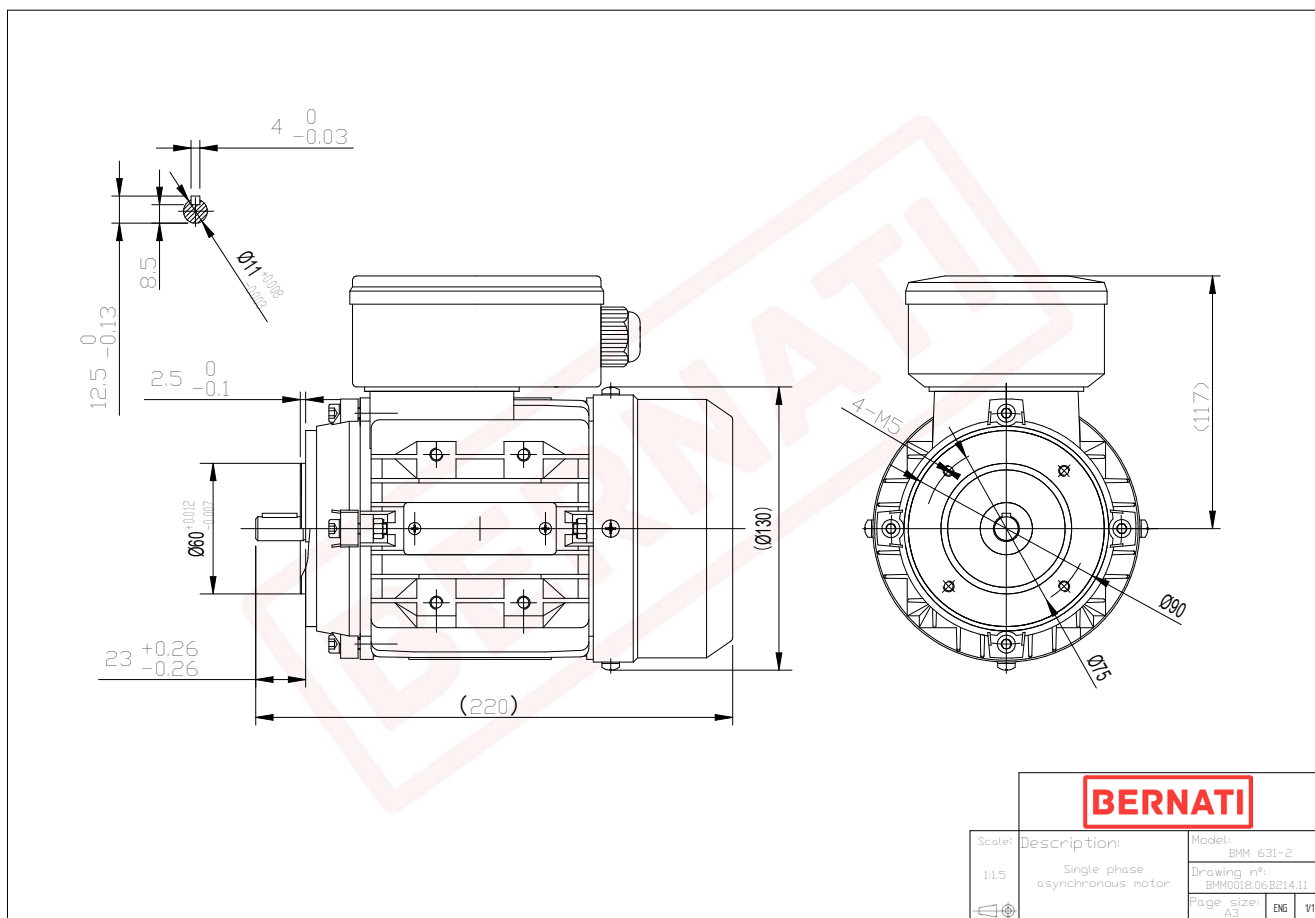

BMM

Product Code	BMM0018.06B214.11
Motor Type/Frame	BMM 631-2
Mounting	IM B14
Output Power (kW)	0.18
Speed (rpm)	2770
Tension (V)	230
Frequency (Hz)	50
Current (A)	1.30
Power factor (Cos Ø)	1.00
Poles	2
Insulation Class	F
IP Class	IP55
100% Efficiency	62.0
Torque (Nm)	0.60
Tstart / Tnominal	0.60
Istart / Inominal	3.20
Tmax / Tnominal	1.80
Noise (dB)	70
PTC Thermistor	N/A
Weight (Kg)	4
DE Bearing	6201 2RZ C3
NDE Bearing	6201 2RZ C3