

Technical Datasheet

BERNATI

BMM Series - Aluminum frame single phase electric motor

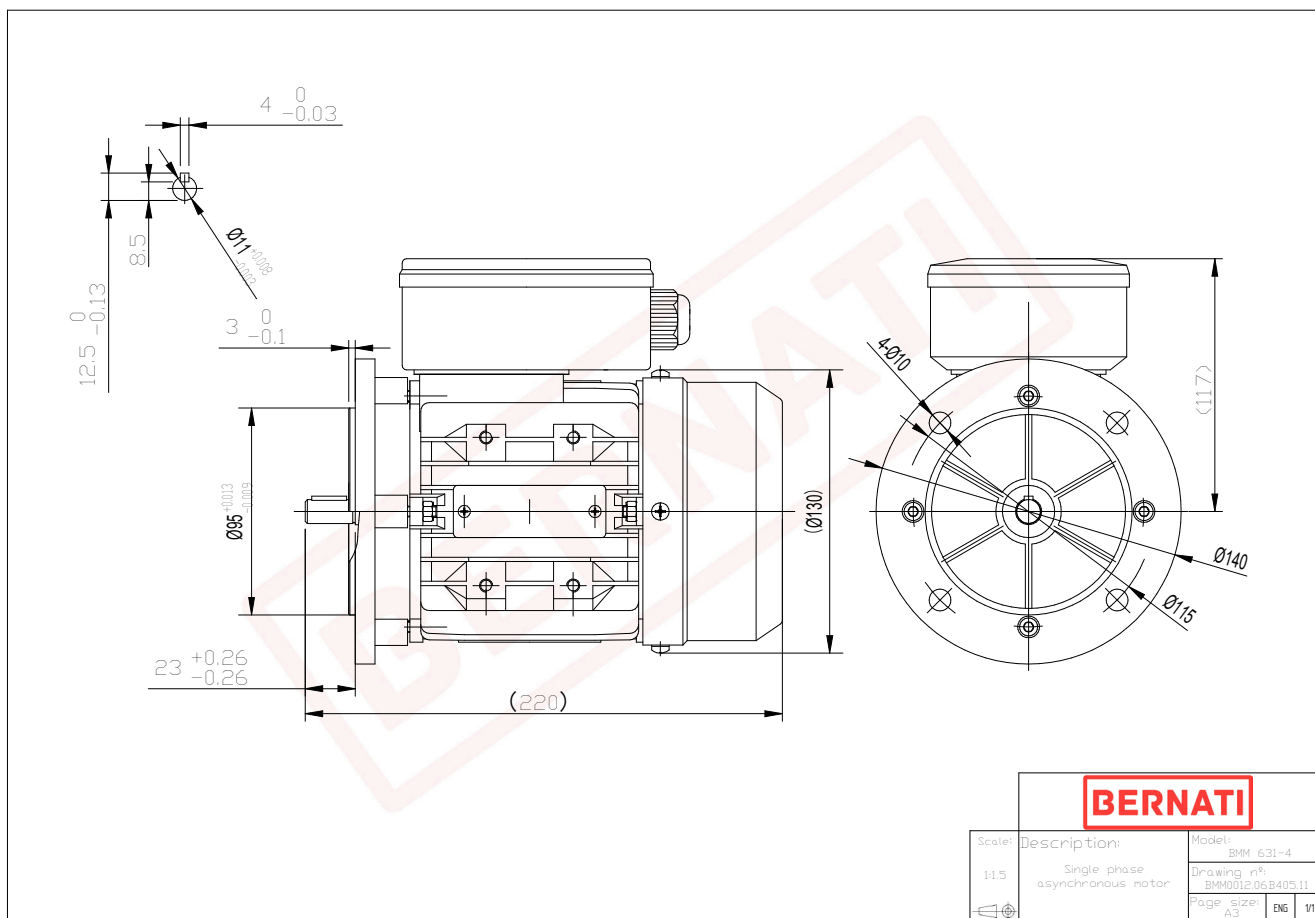

BMM

Product Code	BMM0012.06B405.11
Motor Type/Frame	BMM 631-4
Mounting	IM B5
Output Power (kW)	0.12
Speed (rpm)	1400
Tension (V)	230
Frequency (Hz)	50
Current (A)	1.00
Power factor (Cos Ø)	1.00
Poles	4
Insulation Class	F
IP Class	IP55
100% Efficiency	55.0
Torque (Nm)	0.80
Tstart / Tnominal	0.70
Istart / Inominal	2.50
Tmax / Tnominal	1.80
Noise (dB)	65
PTC Thermistor	N/A
Weight (Kg)	4
DE Bearing	6201 2RZ C3
NDE Bearing	6201 2RZ C3