

Technical Datasheet

BERNATI

BCT Series - Cast iron frame three phase low voltage electric motor

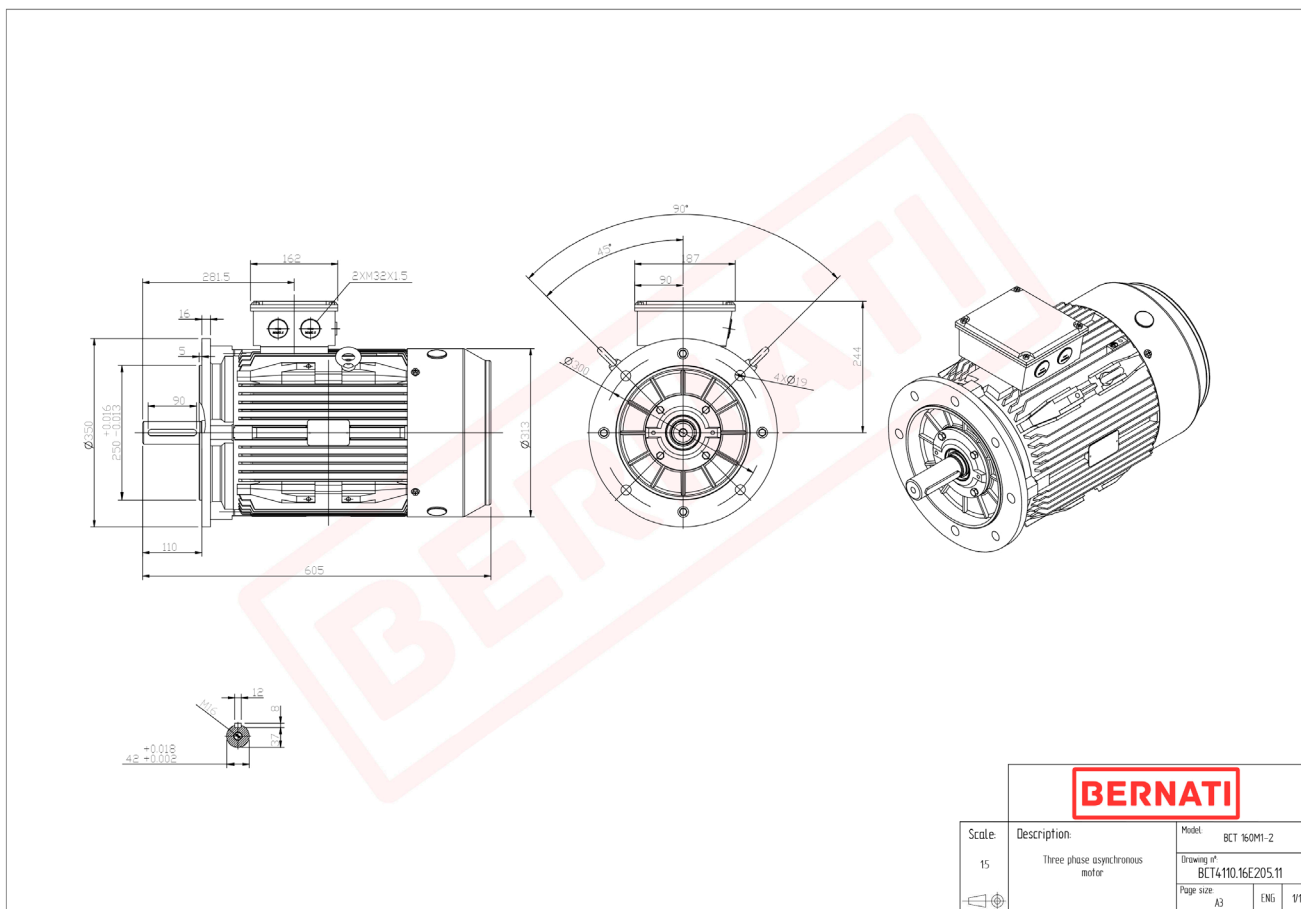

BCT

Product Code	BCT4110.16E205.11
Motor Type/Frame	BCT 160M1-2
Mounting	IM B5
Efficiency Class	IE4
Output Power (kW)	11.00
Speed (rpm)	2960
Tension (V)	230/400
Frequency (Hz)	50
Current (A)	19.30
Power factor (Cos Ø)	0.90
Poles	2
Insulation Class	F
IP Class	IP55
50% Efficiency	92.5
75% Efficiency	92.8
100% Efficiency	92.6
Torque (Nm)	35.50
Tstart / Tnominal	2.00
Istart / Inominal	9.50
Tmax / Tnominal	2.30
Noise (dB)	81
PTC Thermistor	PTC 130
Weight (Kg)	129
DE Bearing	6309 C3
NDE Bearing	6309 C3