

## BCT Series - Cast iron frame three phase low voltage electric motor

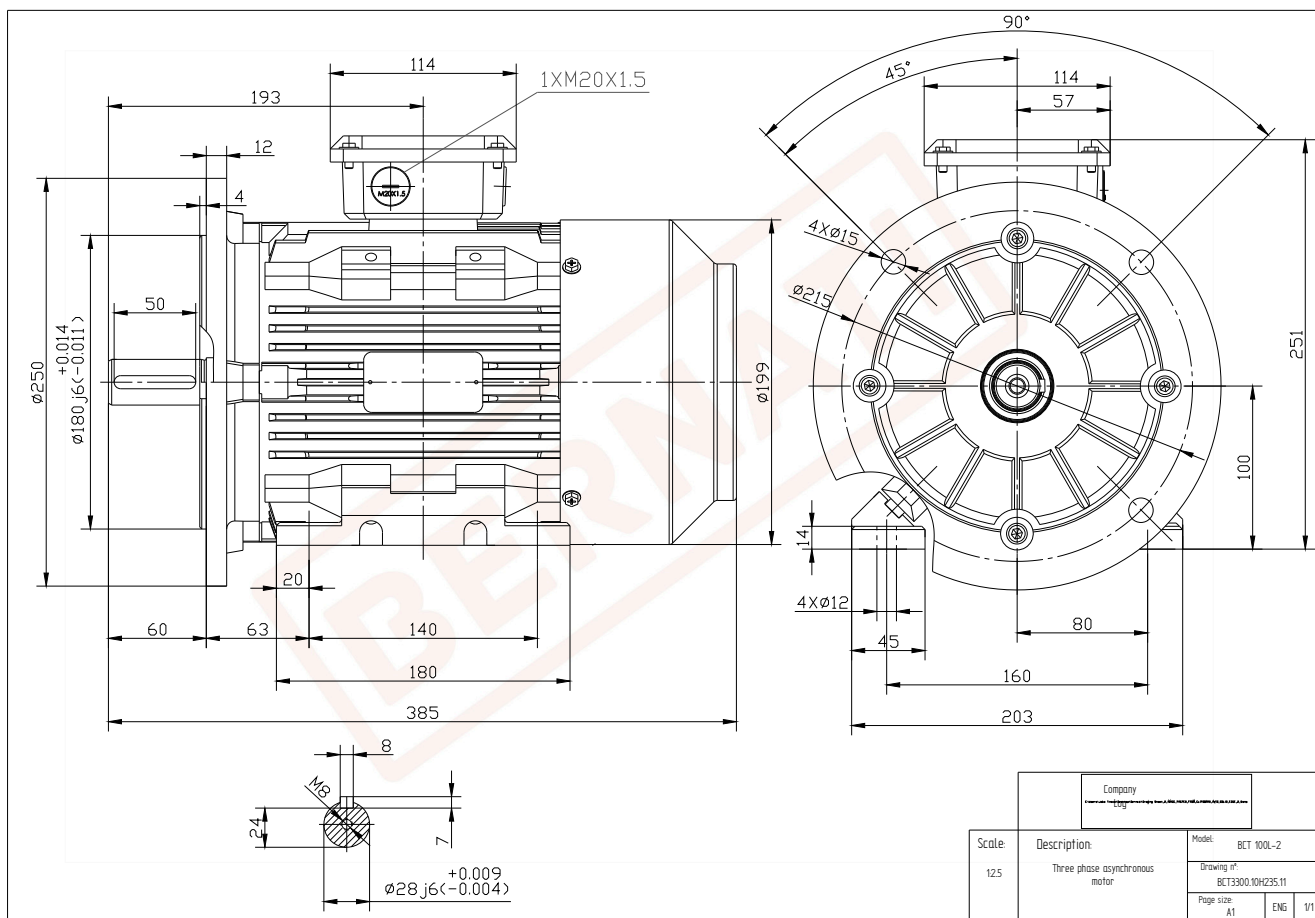

### BCT

Product Code	BCT3300.10H235.11
Motor Type/Frame	BCT 100L-2
Mounting	IM B3/B5
Efficiency Class	IE3
Output Power (kW)	3.00
Speed (rpm)	2900
Tension (V)	230/400
Frequency (Hz)	50
Current (A)	5.70
Power factor (Cos Ø)	0.90
Poles	2
Insulation Class	F
IP Class	IP55
50% Efficiency	86.8
75% Efficiency	88.5
100% Efficiency	87.1
Torque (Nm)	9.90
Tstart / Tnominal	2.50
Istart / Inominal	9.50
Tmax / Tnominal	2.80
Noise (dB)	76
PTC Thermistor	PTC 130
Weight (Kg)	36
DE Bearing	6206 2RZ C3
NDE Bearing	6206 2RZ C3