

## BCT Series - Cast iron frame three phase low voltage electric motor

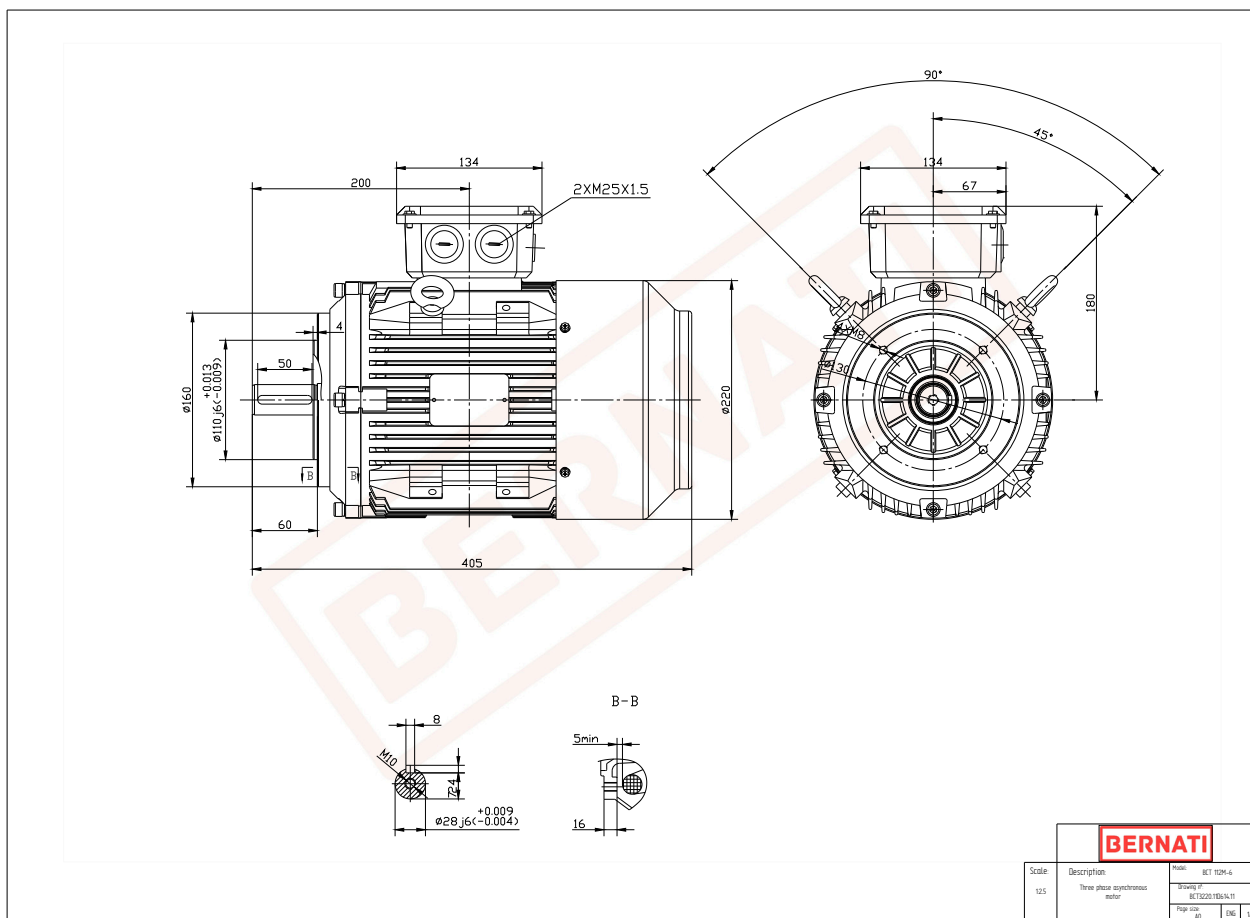

### BCT

Product Code	BCT3220.11D614.11
Motor Type/Frame	BCT 112M-6
Mounting	IM B14
Efficiency Class	IE3
Output Power (kW)	2.20
Speed (rpm)	940
Tension (V)	230/400
Frequency (Hz)	50
Current (A)	5.40
Power factor (Cos Ø)	0.70
Poles	6
Insulation Class	F
IP Class	IP55
50% Efficiency	83.2
75% Efficiency	85.0
100% Efficiency	84.3
Torque (Nm)	22.40
Tstart / Tnominal	2.00
Istart / Inominal	6.20
Tmax / Tnominal	2.20
Noise (dB)	65
PTC Thermistor	PTC 130
Weight (Kg)	40
DE Bearing	6306 2RZ C3
NDE Bearing	6306 2RZ C3