

## BCT Series - Cast iron frame three phase low voltage electric motor

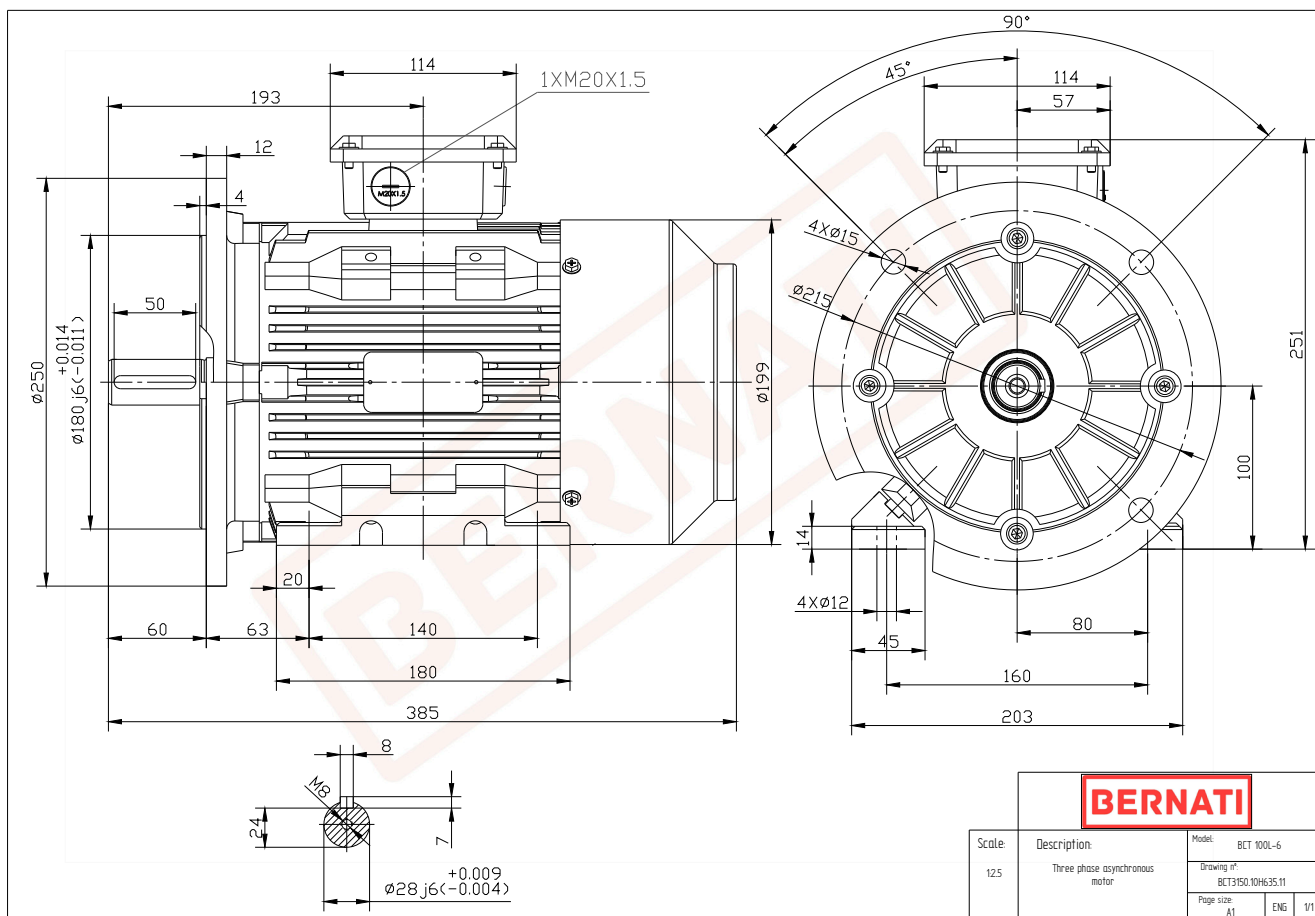

### BCT

Product Code	BCT3150.10H635.11
Motor Type/Frame	BCT 100L-6
Mounting	IM B3/B5
Efficiency Class	IE3
Output Power (kW)	1.50
Speed (rpm)	940
Tension (V)	230/400
Frequency (Hz)	50
Current (A)	3.60
Power factor (Cos Ø)	0.70
Poles	6
Insulation Class	F
IP Class	IP55
50% Efficiency	81.6
75% Efficiency	83.0
100% Efficiency	82.5
Torque (Nm)	15.20
Tstart / Tnominal	2.00
Istart / Inominal	5.20
Tmax / Tnominal	2.20
Noise (dB)	61
PTC Thermistor	PTC 130
Weight (Kg)	34
DE Bearing	6206 2RZ C3
NDE Bearing	6206 2RZ C3