

Technical Datasheet

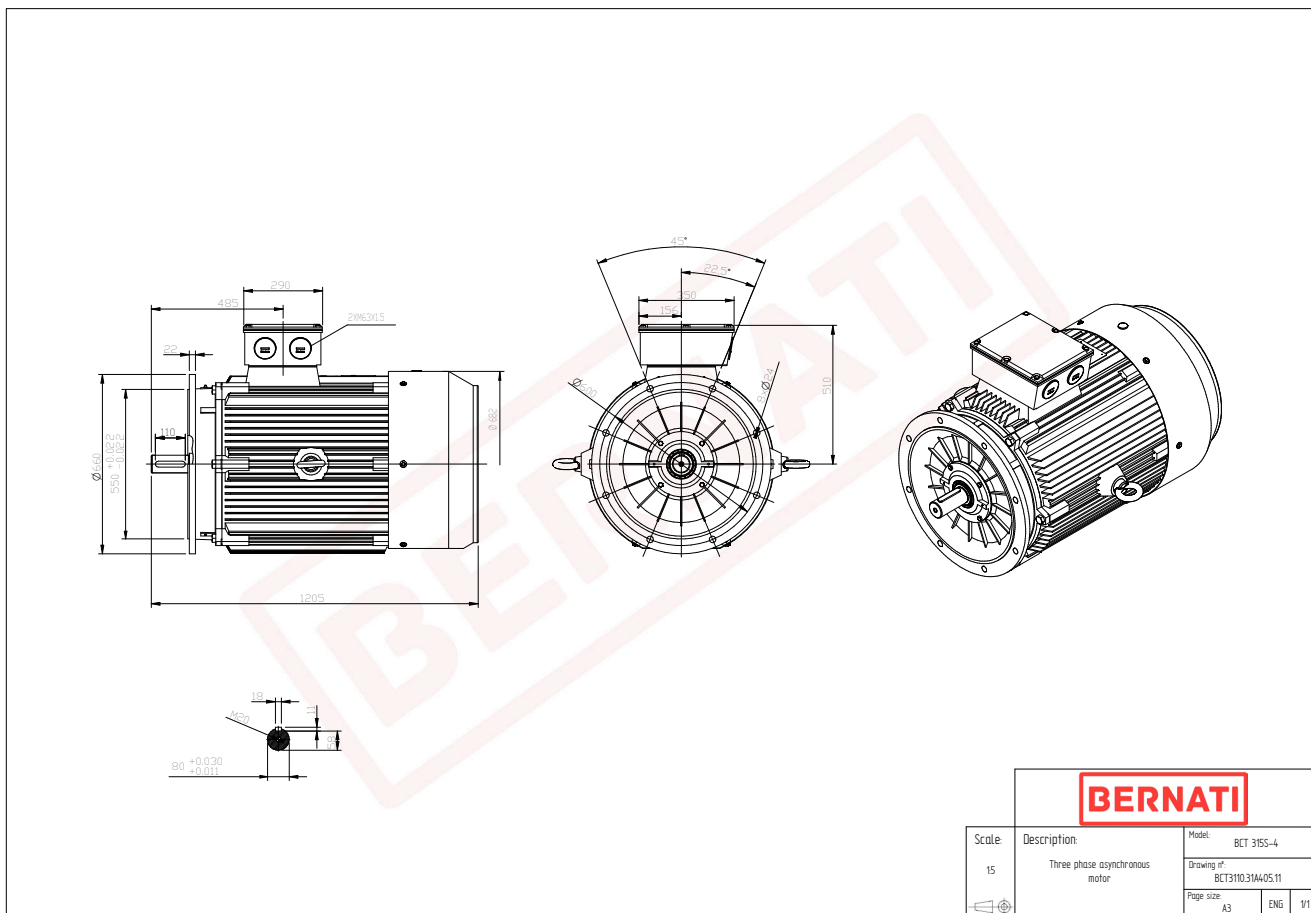

BCT Series - Cast iron frame three phase low voltage electric motor



Scale:	Description:	Model:
15	Three phase asynchronous motor	BCT 315S-4
Drawing n°:		BCT3110.31A405.11
Page size:		A3
		ENG 1/1

BCT

Product Code	BCT3110.31A405.11
Motor Type/Frame	BCT 315S-4
Mounting	IM B5
Efficiency Class	IE3
Output Power (kW)	110.00
Speed (rpm)	1480
Tension (V)	230/400
Frequency (Hz)	50
Current (A)	189.10
Power factor (Cos Ø)	0.90
Poles	4
Insulation Class	F
IP Class	IP55
50% Efficiency	94.6
75% Efficiency	95.7
100% Efficiency	95.4
Torque (Nm)	709.80
Tstart / Tnominal	2.20
Istart / Inominal	9.00
Tmax / Tnominal	2.60
Noise (dB)	93
PTC Thermistor	PTC 130
Weight (Kg)	1027
DE Bearing	NU319
NDE Bearing	6319 C3