

Technical Datasheet

BERNATI

BCL Series - Aluminum frame three phase low voltage electric motor

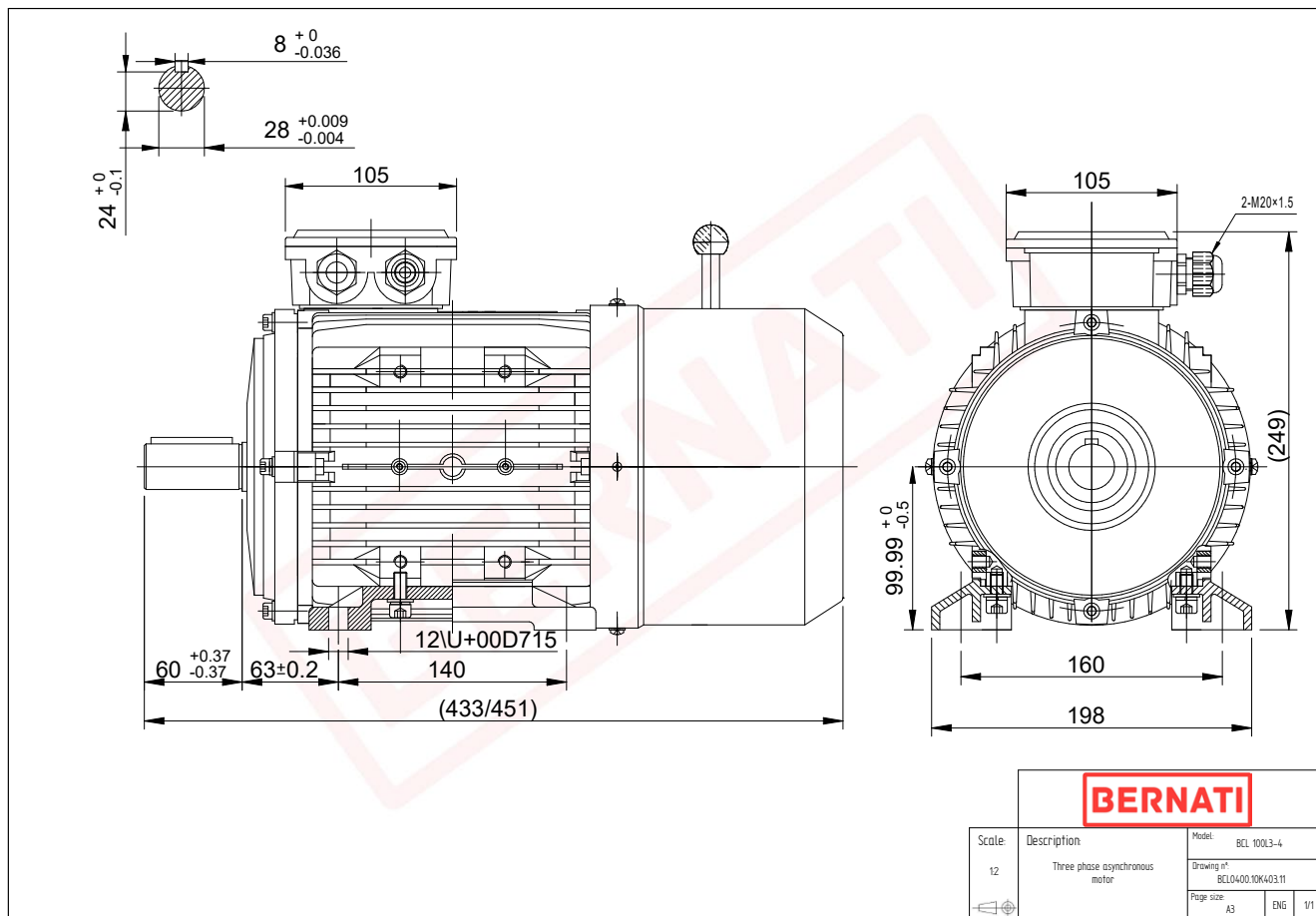

BCL

Product Code	BCL0400.10K403.11
Motor Type/Frame	BCL 100L3-4
Mounting	IM B3
Output Power (kW)	4.00
Speed (rpm)	1430
Tension (V)	230/400
Frequency (Hz)	50
Current (A)	8.40
Power factor (Cos Ø)	0.80
Poles	4
Insulation Class	F
IP Class	IP55
50% Efficiency	85.3
75% Efficiency	85.5
100% Efficiency	84.2
Tstart / Tnominal	2.20
Istart / Inominal	7.00
Tmax / Tnominal	2.30
Noise (dB)	65
PTC Thermistor	N/A
Weight (Kg)	33
DE Bearing	6206 2RZ C3
NDE Bearing	6206 2RZ C3