

Technical Datasheet

BERNATI

BCL Series - Aluminum frame three phase low voltage electric motor

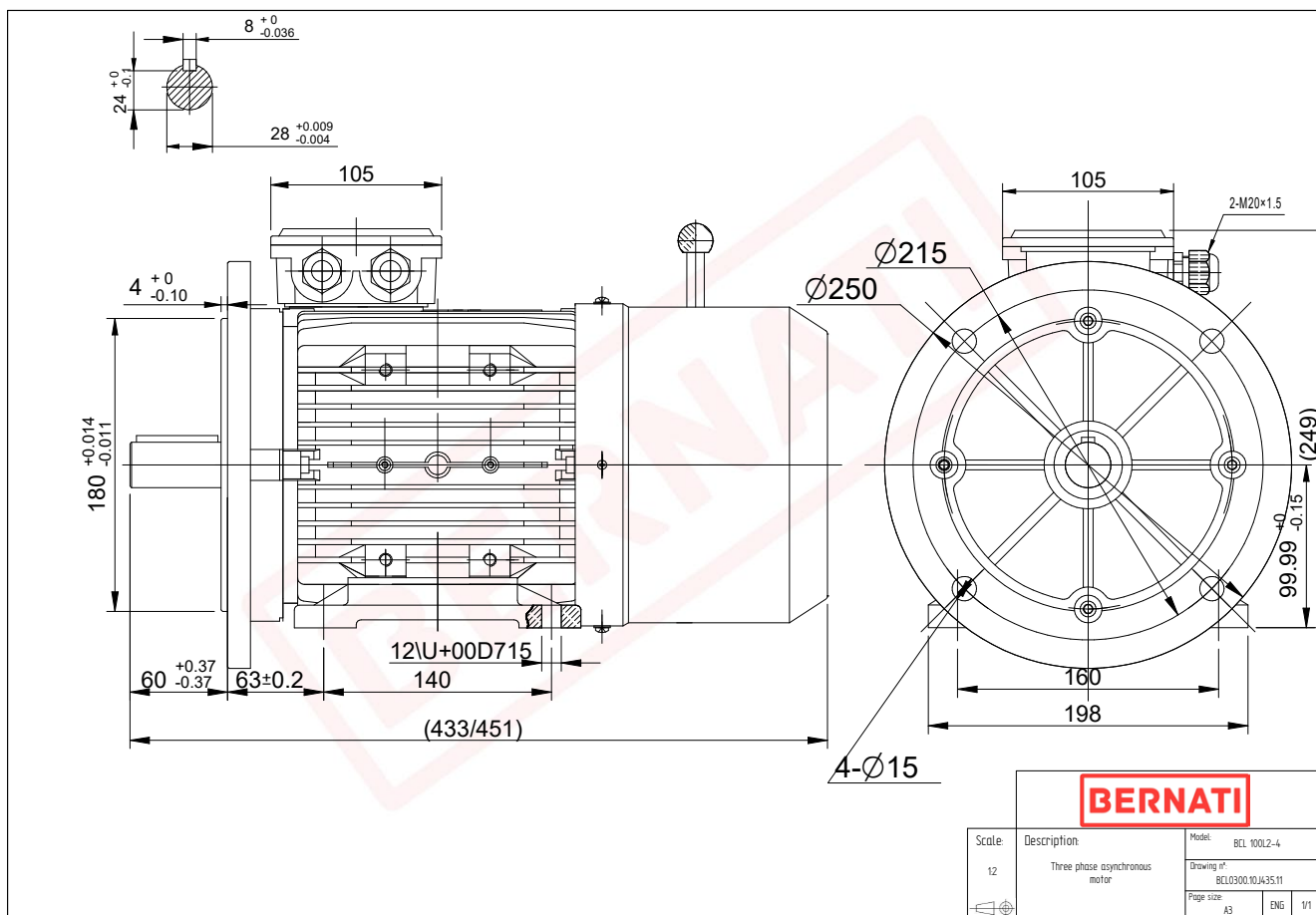

BCL

Product Code	BCL0300.10J435.11
Motor Type/Frame	BCL 100L2-4
Mounting	IM B3/B5
Output Power (kW)	3.00
Speed (rpm)	1430
Tension (V)	230/400
Frequency (Hz)	50
Current (A)	6.30
Power factor (Cos Ø)	0.80
Poles	4
Insulation Class	F
IP Class	IP55
50% Efficiency	83.8
75% Efficiency	84.8
100% Efficiency	83.7
Tstart / Tnominal	2.60
Istart / Inominal	6.80
Tmax / Tnominal	3.00
Noise (dB)	64
PTC Thermistor	N/A
Weight (Kg)	29
DE Bearing	6206 2RZ C3
NDE Bearing	6206 2RZ C3