

Technical Datasheet

BERNATI

BCL Series - Aluminum frame three phase low voltage electric motor

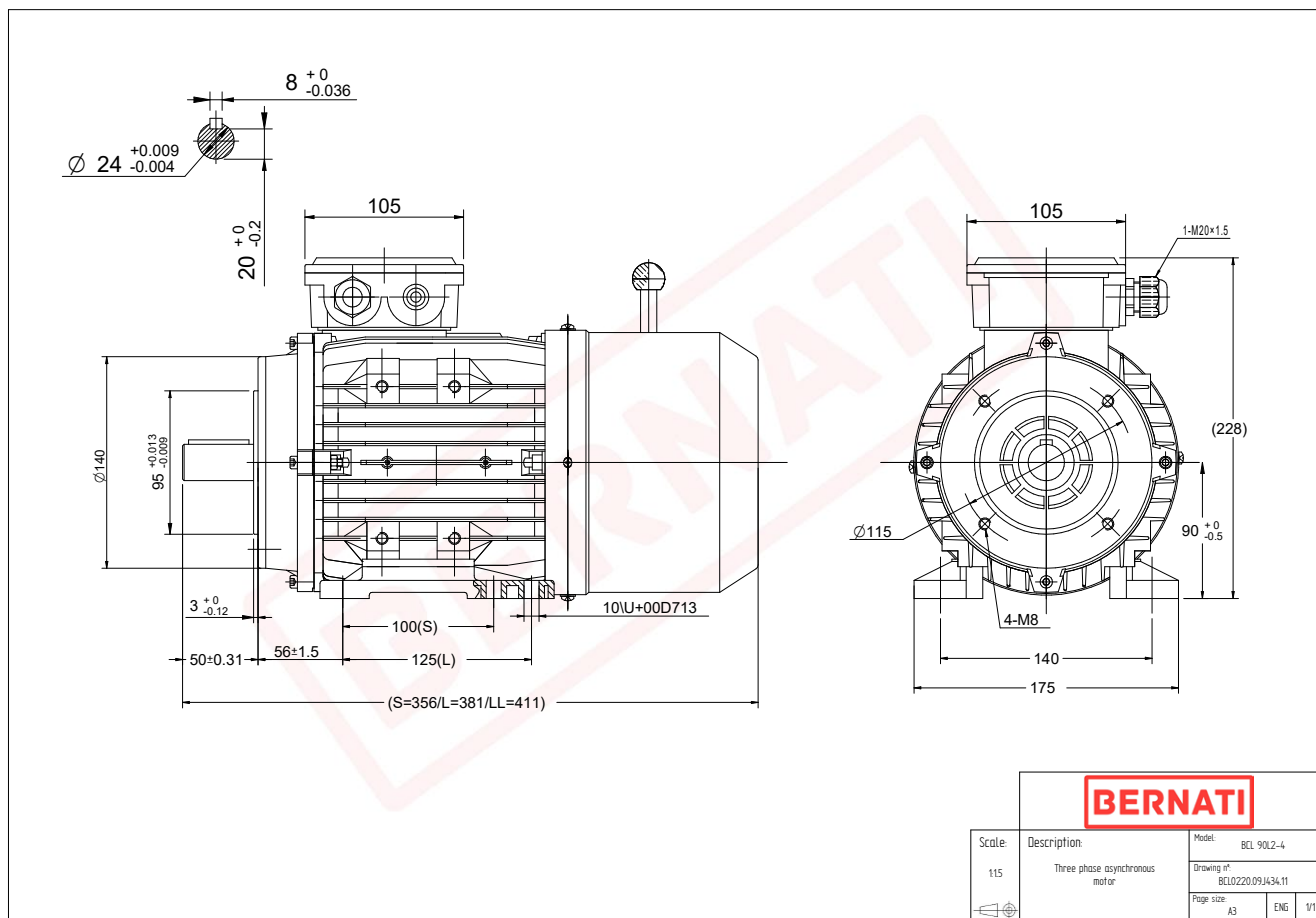

BCL

Product Code	BCL0220.09J434.11
Motor Type/Frame	BCL 90L2-4
Mounting	IM B3/B14
Output Power (kW)	2.20
Speed (rpm)	1410
Tension (V)	230/400
Frequency (Hz)	50
Current (A)	5.40
Power factor (Cos Ø)	0.80
Poles	4
Insulation Class	F
IP Class	IP55
50% Efficiency	77.0
75% Efficiency	79.4
100% Efficiency	78.9
Tstart / Tnominal	3.80
Istart / Inominal	7.20
Tmax / Tnominal	2.60
Noise (dB)	63
PTC Thermistor	N/A
Weight (Kg)	23
DE Bearing	6205 2RZ C3
NDE Bearing	6205 2RZ C3