

# Technical Datasheet

**BERNATI**

BCL Series - Aluminum frame three phase low voltage electric motor

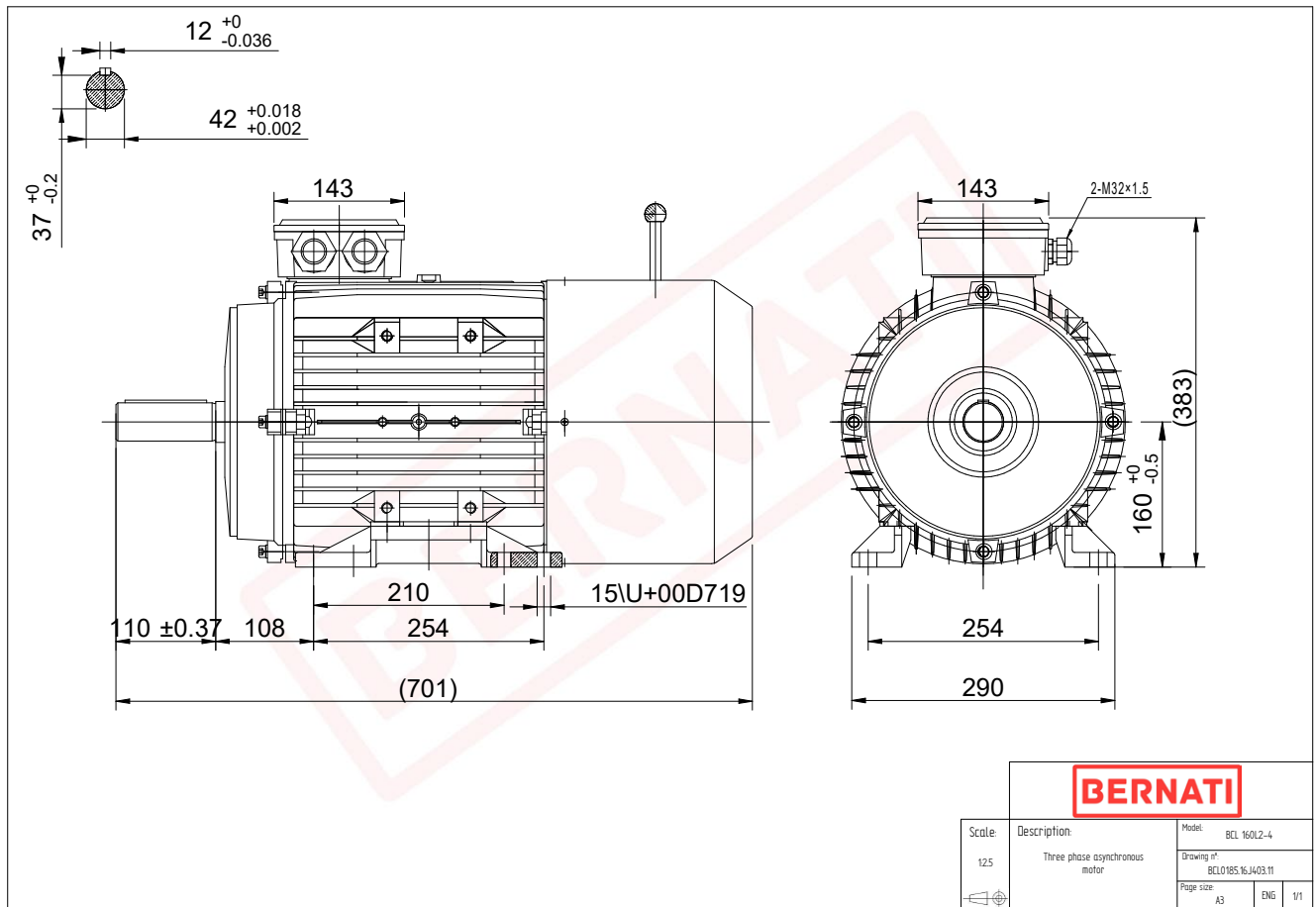

## BCL

Product Code	BCL0185.16J403.11
Motor Type/Frame	BCL 160L2-4
Mounting	IM B3
Output Power (kW)	18.50
Speed (rpm)	1460
Tension (V)	230/400
Frequency (Hz)	50
Current (A)	34.70
Power factor (Cos Ø)	0.90
Poles	4
Insulation Class	F
IP Class	IP55
50% Efficiency	90.6
75% Efficiency	91.0
100% Efficiency	90.5
Tstart / Tnominal	2.20
Istart / Inominal	7.50
Tmax / Tnominal	2.20
Noise (dB)	78
PTC Thermistor	N/A
Weight (Kg)	115
DE Bearing	6309 2RZ C3
NDE Bearing	6209 2RZ C3