

Technical Datasheet

BERNATI

BCL Series - Aluminum frame three phase low voltage electric motor

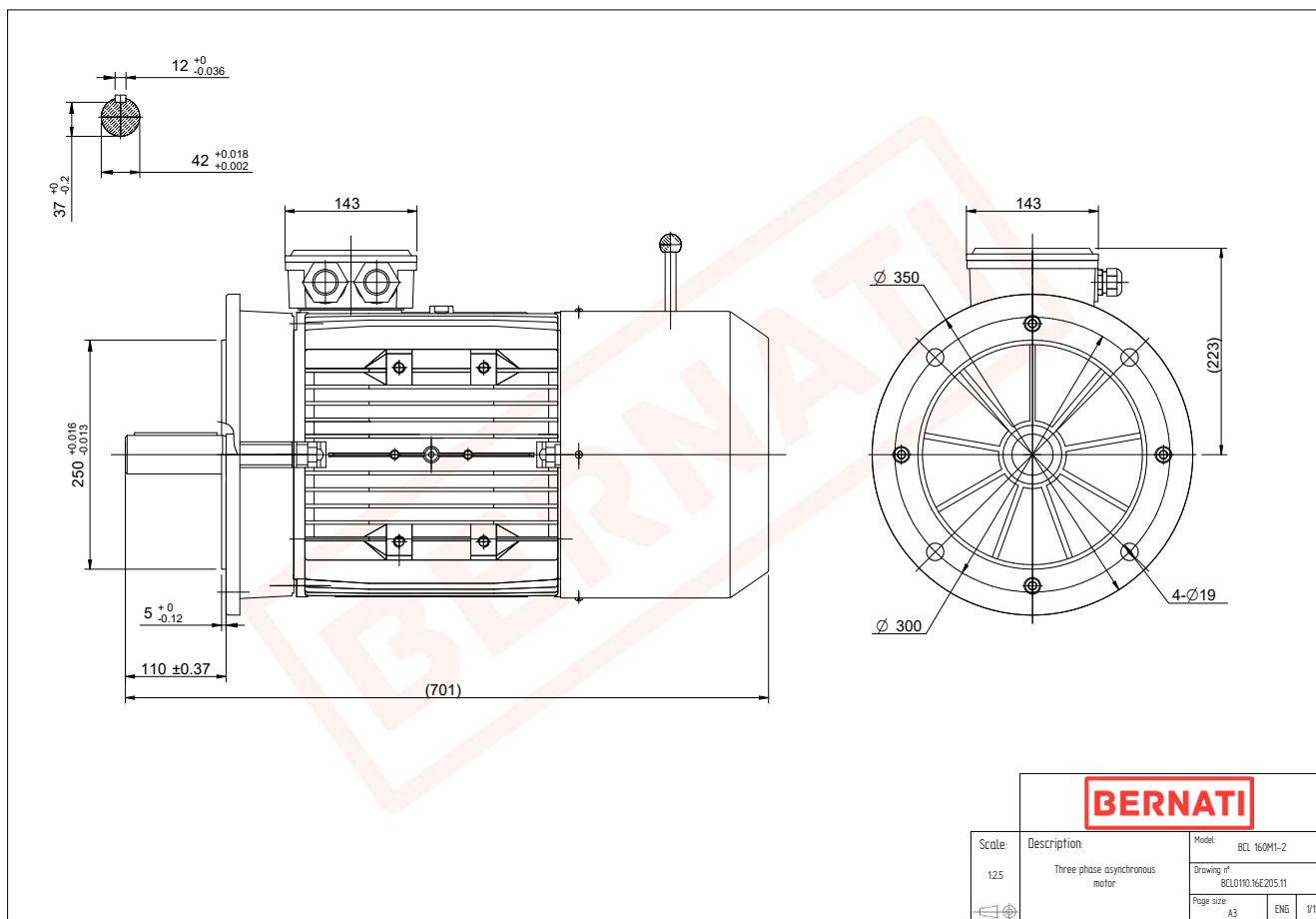

BCL

Product Code	BCL0110.16E205.11
Motor Type/Frame	BCL 160M1-2
Mounting	IM B5
Output Power (kW)	11.00
Speed (rpm)	2920
Tension (V)	230/400
Frequency (Hz)	50
Current (A)	20.00
Power factor (Cos Ø)	0.90
Poles	2
Insulation Class	F
IP Class	IP55
50% Efficiency	88.6
75% Efficiency	89.4
100% Efficiency	88.8
Tstart / Tnominal	2.60
Istart / Inominal	7.10
Tmax / Tnominal	3.00
Noise (dB)	86
PTC Thermistor	N/A
Weight (Kg)	92
DE Bearing	6309 2RZ C3
NDE Bearing	6209 2RZ C3