

Technical Datasheet

BERNATI

BCL Series - Aluminum frame three phase low voltage electric motor

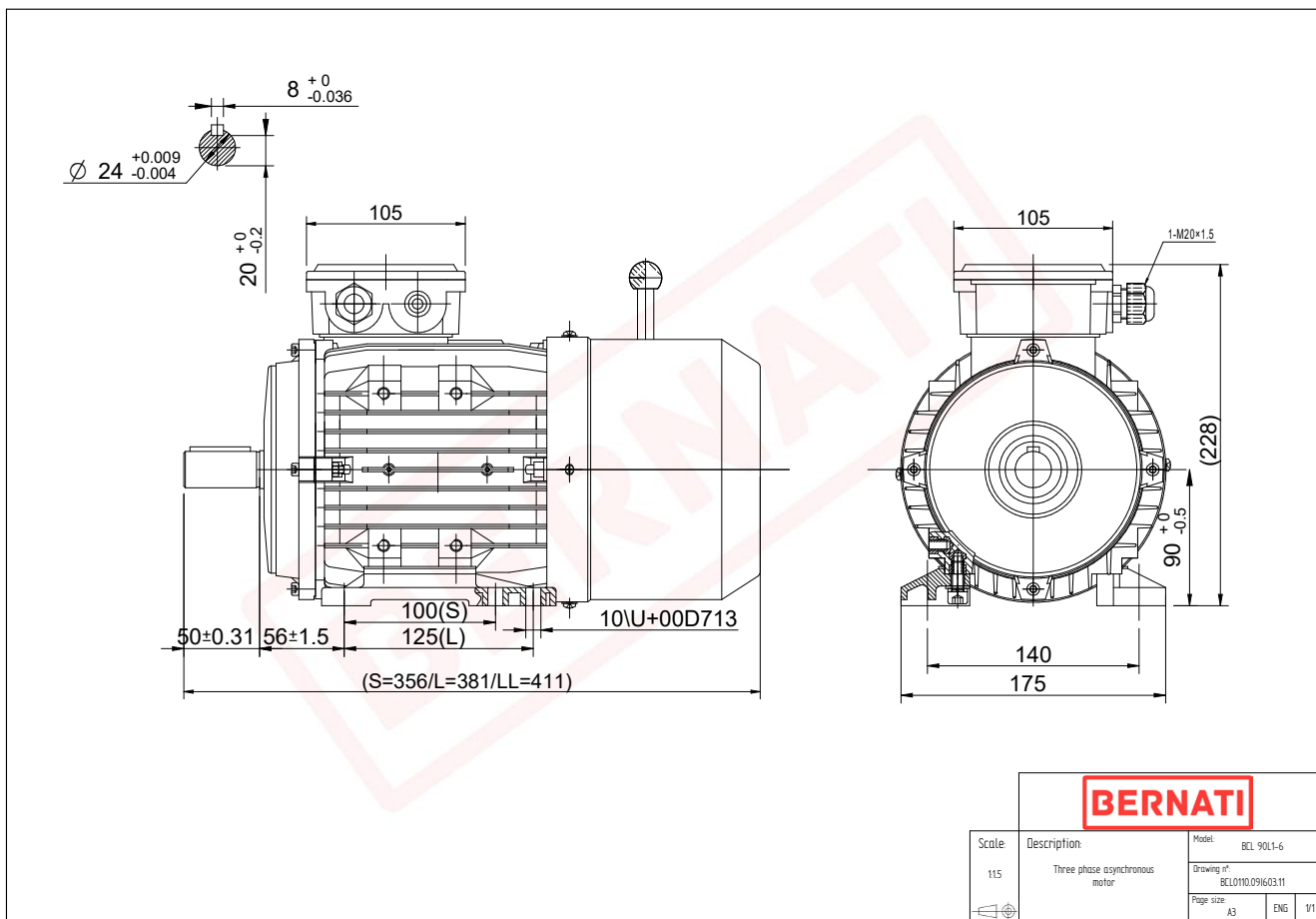

BCL

Product Code	BCL0110.091603.11
Motor Type/Frame	BCL 90L1-6
Mounting	IM B3
Output Power (kW)	1.10
Speed (rpm)	910
Tension (V)	230/400
Frequency (Hz)	50
Current (A)	3.00
Power factor (Cos Ø)	0.70
Poles	6
Insulation Class	F
IP Class	IP55
50% Efficiency	72.9
75% Efficiency	75.2
100% Efficiency	73.5
Tstart / Tnominal	2.00
Istart / Inominal	4.20
Tmax / Tnominal	2.30
Noise (dB)	59
PTC Thermistor	N/A
Weight (Kg)	18
DE Bearing	6205 2RZ C3
NDE Bearing	6205 2RZ C3