

Technical Datasheet

BERNATI

BCL Series - Aluminum frame three phase low voltage electric motor

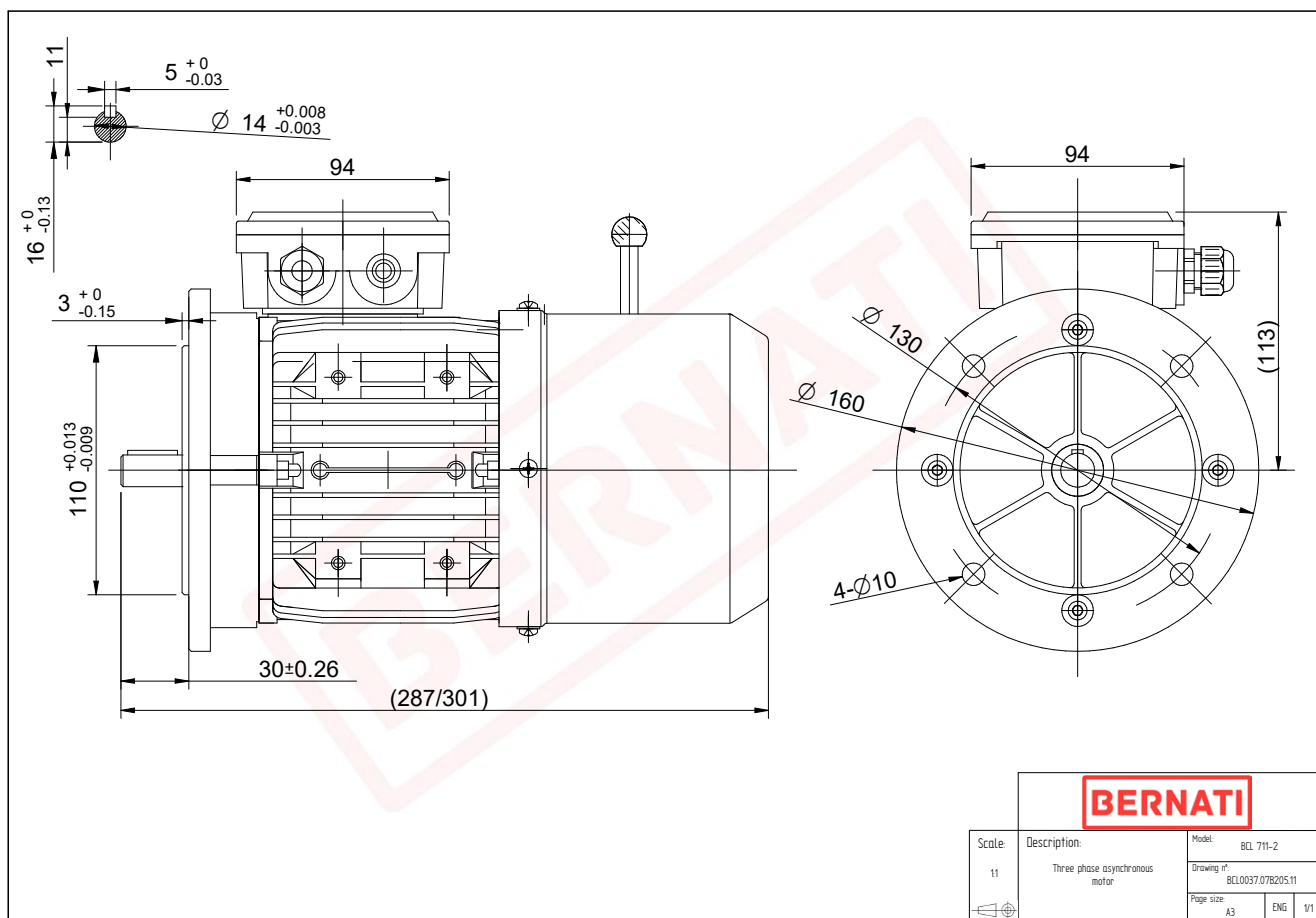

BCL

Product Code	BCL0037.07B205.11
Motor Type/Frame	BCL 711-2
Mounting	IM B5
Output Power (kW)	0.37
Speed (rpm)	2830
Tension (V)	230/400
Frequency (Hz)	50
Current (A)	0.90
Power factor (Cos Ø)	0.80
Poles	2
Insulation Class	F
IP Class	IP55
50% Efficiency	65.2
75% Efficiency	70.4
100% Efficiency	71.3
Tstart / Tnominal	2.80
Istart / Inominal	5.90
Tmax / Tnominal	2.90
Noise (dB)	64
PTC Thermistor	N/A
Weight (Kg)	7
DE Bearing	6202 2RZ C3
NDE Bearing	6202 2RZ C3