

Technical Datasheet

BERNATI

BMT Series - Aluminum frame three phase low voltage electric motor

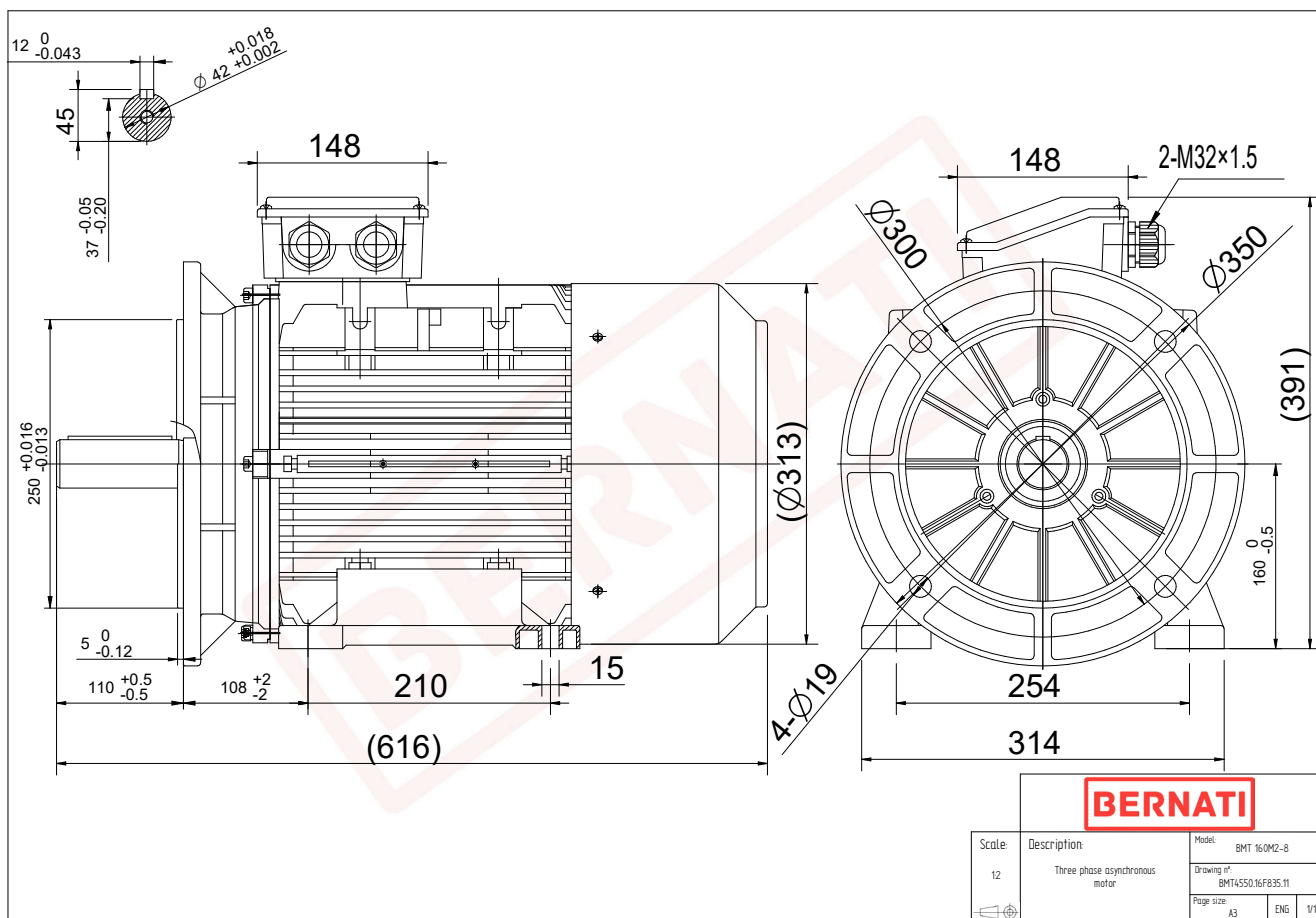

BMT

Product Code	BMT4550.16F835.11
Motor Type/Frame	BMT 160M2-8
Mounting	IM B3/B5
Efficiency Class	IE4
Output Power (kW)	5.50
Speed (rpm)	725
Tension (V)	230/400
Frequency (Hz)	50
Current (A)	12.80
Power factor (Cos Ø)	0.70
Poles	8
Insulation Class	F
IP Class	IP55
50% Efficiency	87.8
75% Efficiency	88.7
100% Efficiency	88.3
Torque (Nm)	75.50
Tstart / Tnominal	2.50
Istart / Inominal	6.10
Tmax / Tnominal	1.80
Noise (dB)	68
PTC Thermistor	PTC 130
Weight (Kg)	94
DE Bearing	6309 2RZ C3
NDE Bearing	6209 2RZ C3