

Technical Datasheet

BERNATI

BMT Series - Aluminum frame three phase low voltage electric motor

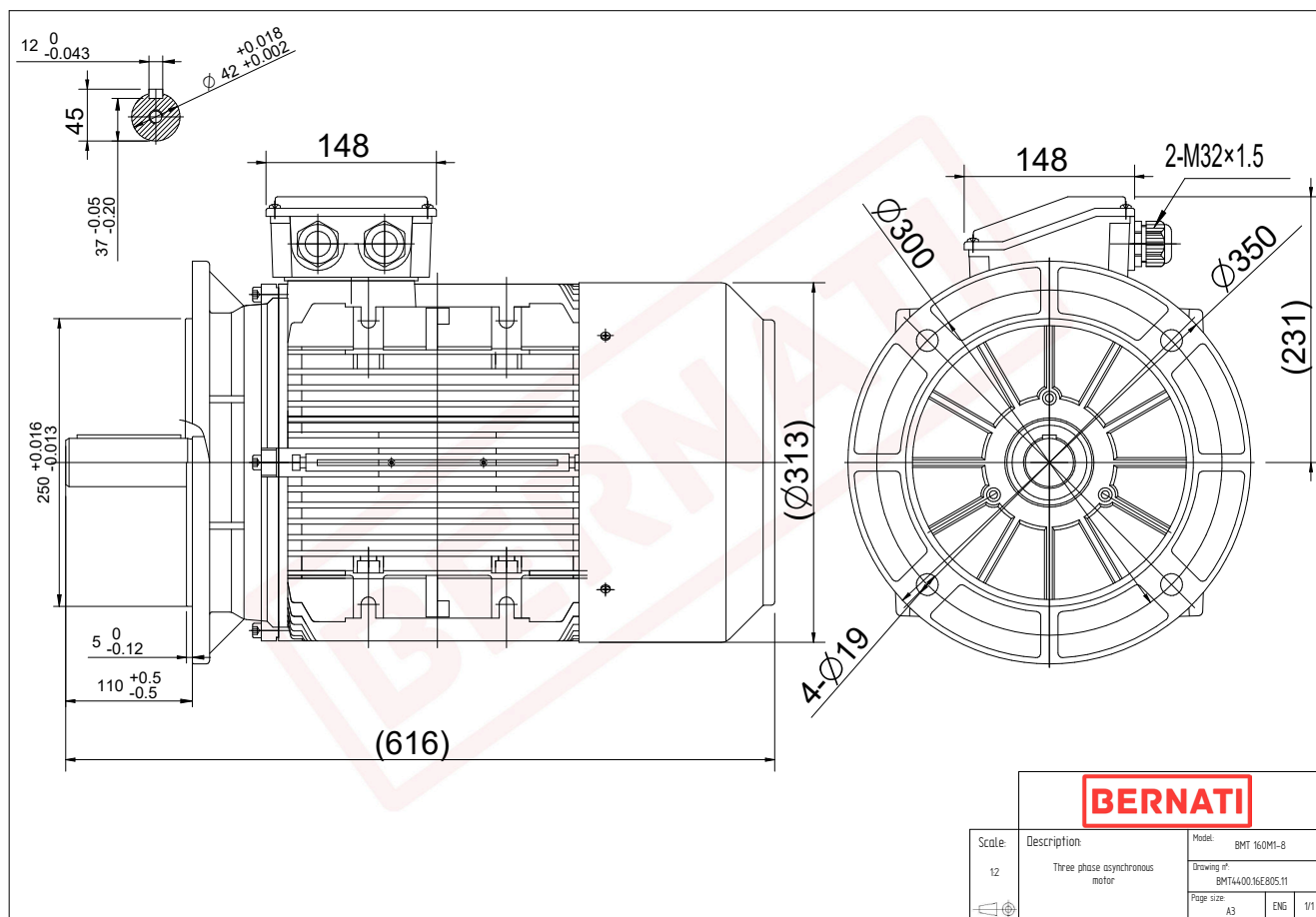

BMT

Product Code	BMT4400.16E805.11
Motor Type/Frame	BMT 160M1-8
Mounting	IM B5
Efficiency Class	IE4
Output Power (kW)	4.00
Speed (rpm)	725
Tension (V)	230/400
Frequency (Hz)	50
Current (A)	9.60
Power factor (Cos Ø)	0.70
Poles	8
Insulation Class	F
IP Class	IP55
50% Efficiency	86.3
75% Efficiency	87.5
100% Efficiency	87.1
Torque (Nm)	54.90
Tstart / Tnominal	2.20
Istart / Inominal	5.60
Tmax / Tnominal	1.70
Noise (dB)	68
PTC Thermistor	PTC 130
Weight (Kg)	76
DE Bearing	6309 2RZ C3
NDE Bearing	6209 2RZ C3