

Technical Datasheet

BERNATI

BMT Series - Aluminum frame three phase low voltage electric motor

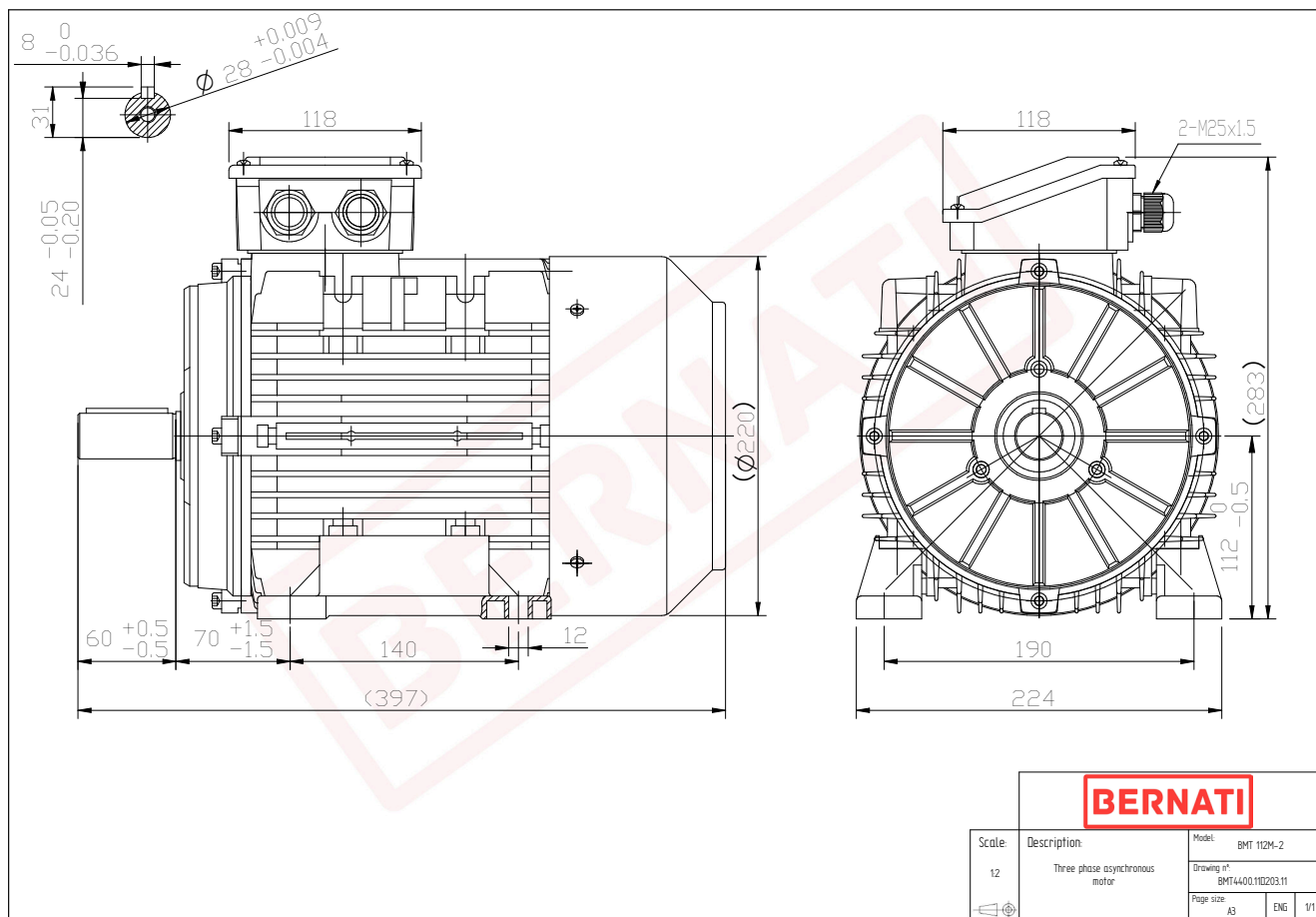

BMT

Product Code	BMT4400.11D203.11
Motor Type/Frame	BMT 112M-2
Mounting	IM B3
Efficiency Class	IE4
Output Power (kW)	4.00
Speed (rpm)	2920
Tension (V)	230/400
Frequency (Hz)	50
Current (A)	7.10
Power factor (Cos Ø)	0.90
Poles	2
Insulation Class	F
IP Class	IP55
50% Efficiency	89.7
75% Efficiency	90.4
100% Efficiency	90.0
Torque (Nm)	13.6
Tstart / Tnominal	3.50
Istart / Inominal	10.5
Tmax / Tnominal	2.60
Noise (dB)	77
PTC Thermistor	PTC 130
Weight (Kg)	35
DE Bearing	6306 2RZ C3
NDE Bearing	6206 2RZ C3