

Technical Datasheet

BERNATI

BMT Series - Aluminum frame three phase low voltage electric motor

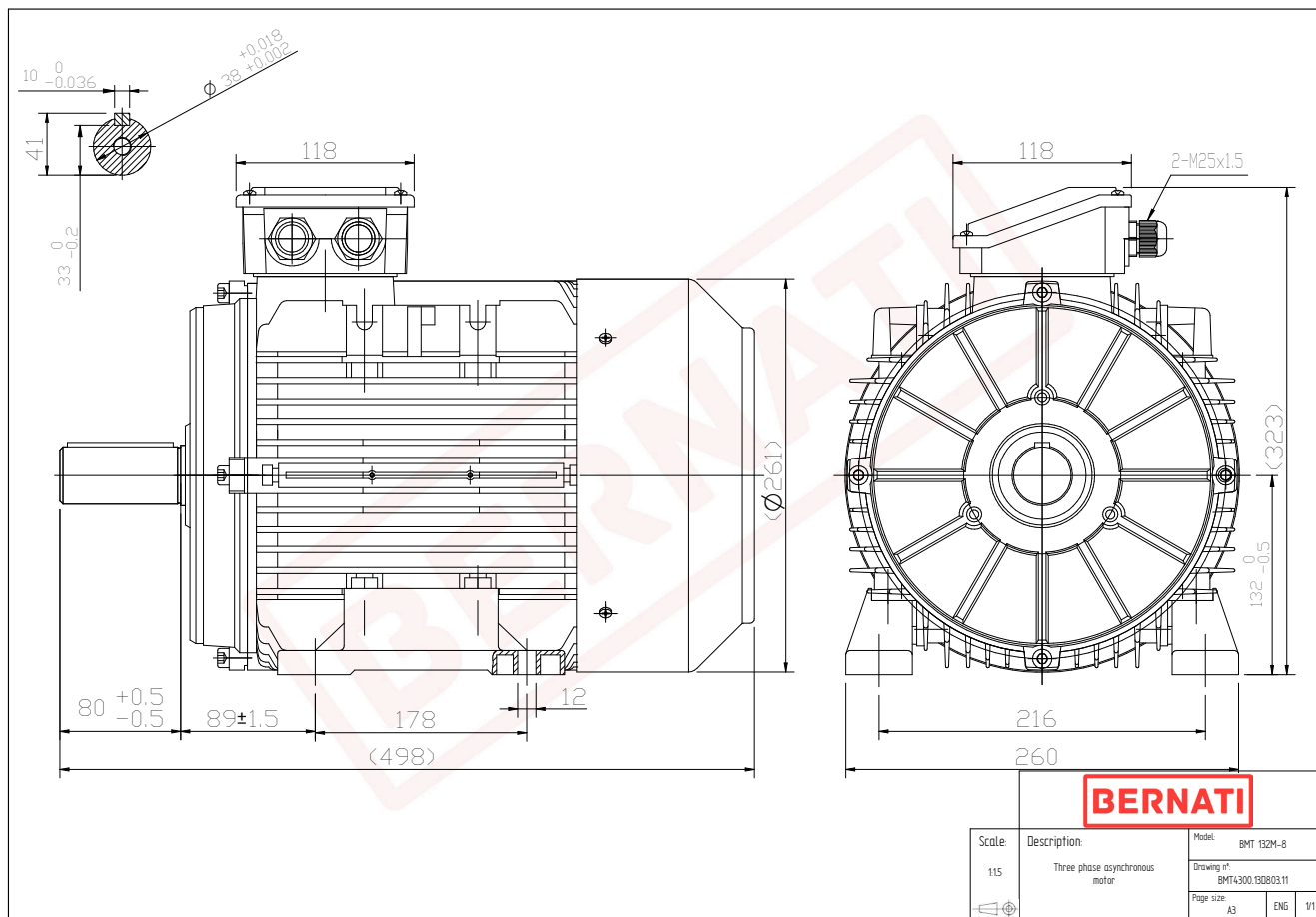

BMT	
Product Code	BMT4300.13D803.11
Motor Type/Frame	BMT 132M-8
Mounting	IM B3
Efficiency Class	IE4
Output Power (kW)	3.00
Speed (rpm)	725
Tension (V)	230/400
Frequency (Hz)	50
Current (A)	7.50
Power factor (Cos Ø)	0.70
Poles	8
Insulation Class	F
IP Class	IP55
50% Efficiency	84.2
75% Efficiency	86.0
100% Efficiency	85.9
Torque (Nm)	41.20
Tstart / Tnominal	2.50
Istart / Inominal	6.30
Tmax / Tnominal	2.10
Noise (dB)	64
PTC Thermistor	PTC 130
Weight (Kg)	61
DE Bearing	6308 2RZ C3
NDE Bearing	6208 2RZ C3