

# Technical Datasheet

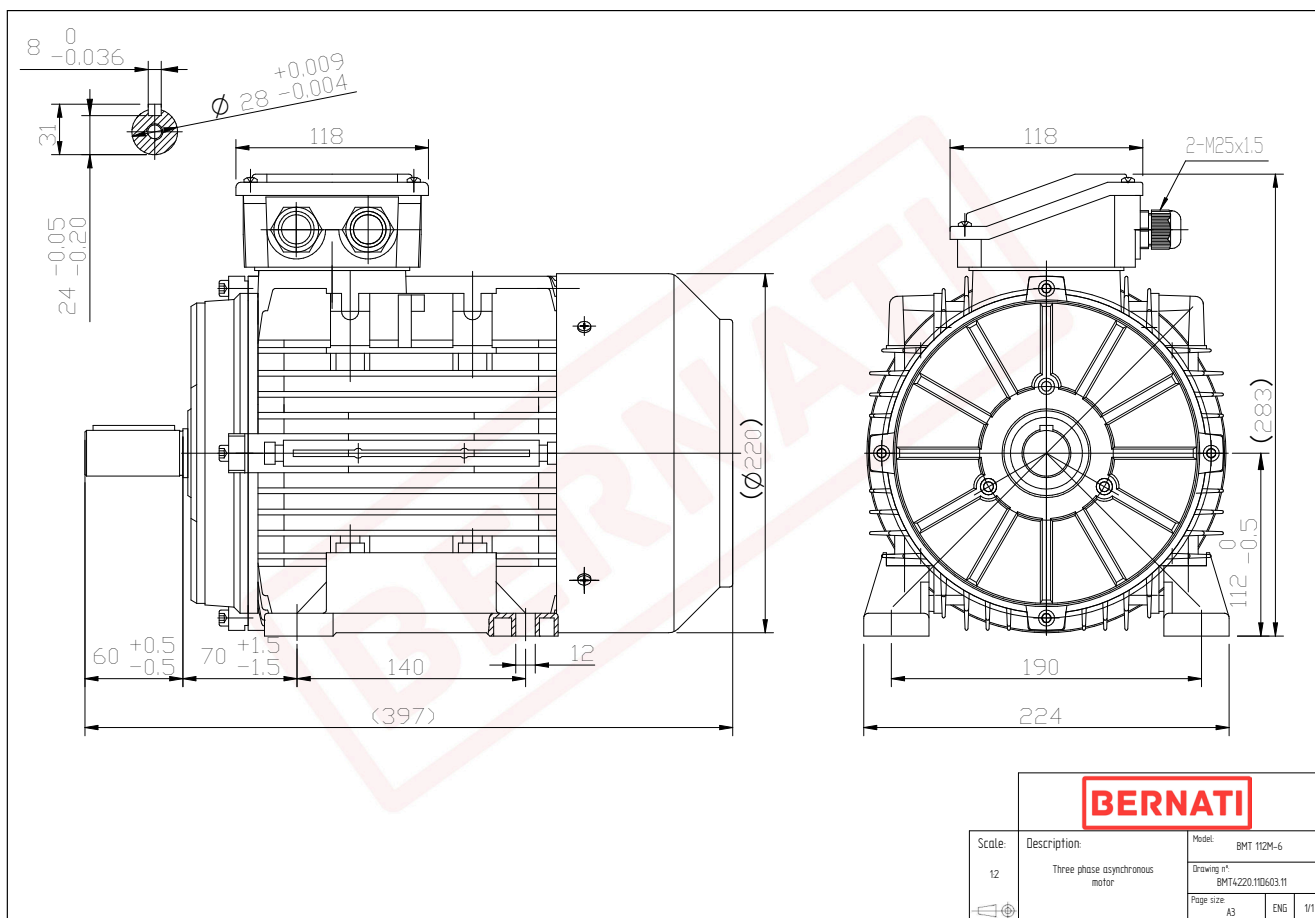

## BMT Series - Aluminum frame three phase low voltage electric motor



<b>BMT</b>	
Product Code	BMT4220.11D603.11
Motor Type/Frame	BMT 112M-6
Mounting	IM B3
Efficiency Class	IE4
Output Power (kW)	2.20
Speed (rpm)	970
Tension (V)	230/400
Frequency (Hz)	50
Current (A)	5.00
Power factor (Cos Ø)	0.70
Poles	6
Insulation Class	F
IP Class	IP55
50% Efficiency	85.4
75% Efficiency	87.2
100% Efficiency	87.4
Torque (Nm)	22.60
Tstart / Tnominal	3.00
Istart / Inominal	7.50
Tmax / Tnominal	2.60
Noise (dB)	64
PTC Thermistor	PTC 130
Weight (Kg)	35
DE Bearing	6306 2RZ C3
NDE Bearing	6206 2RZ C3