

Technical Datasheet

BERNATI

BMT Series - Aluminum frame three phase low voltage electric motor

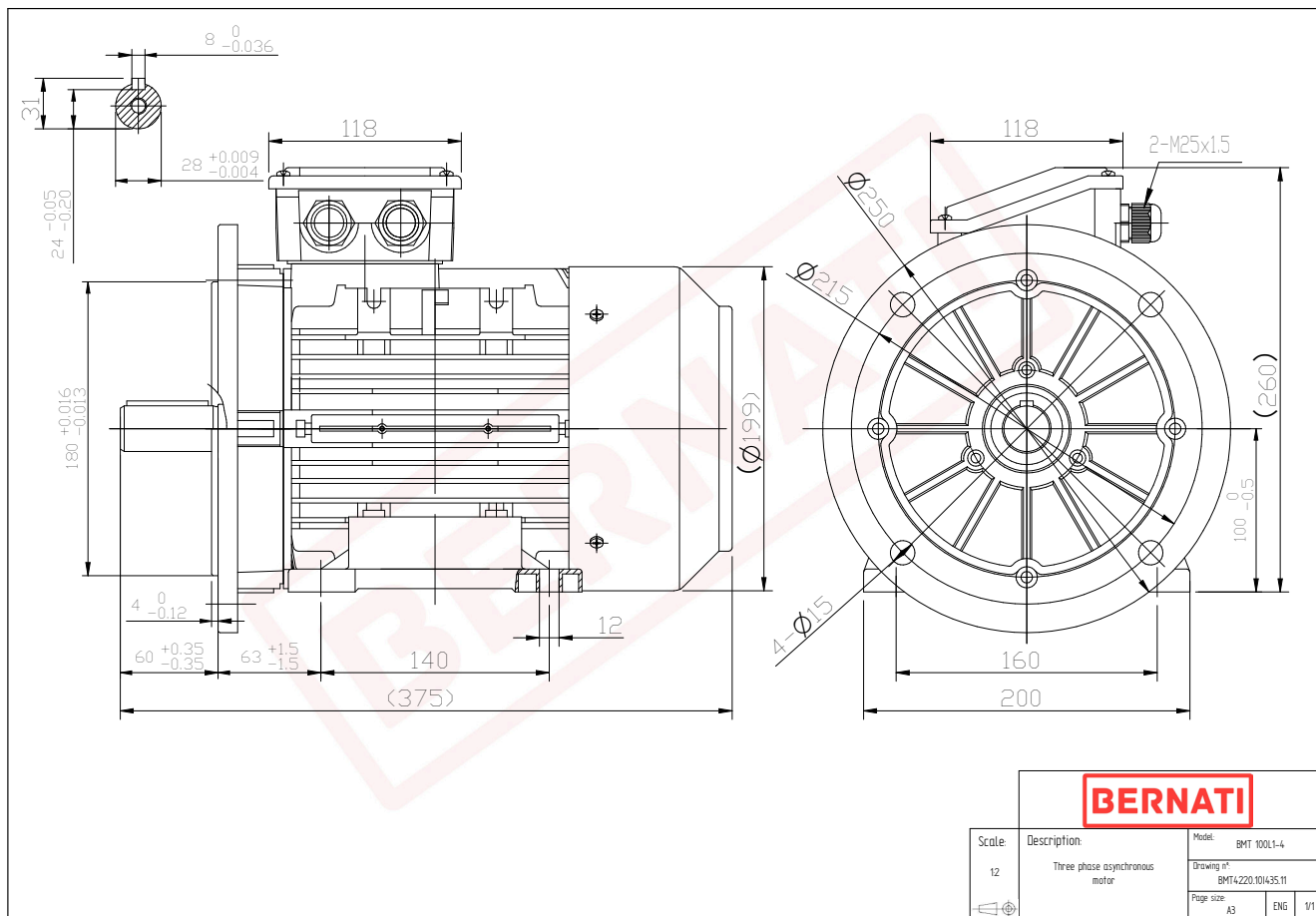

BMT	
Product Code	BMT4220.10I435.11
Motor Type/Frame	BMT 100L1-4
Mounting	IM B3/B5
Efficiency Class	IE4
Output Power (kW)	2.20
Speed (rpm)	1460
Tension (V)	230/400
Frequency (Hz)	50
Current (A)	4.70
Power factor (Cos Ø)	0.80
Poles	4
Insulation Class	F
IP Class	IP55
50% Efficiency	88.2
75% Efficiency	89.6
100% Efficiency	89.5
Torque (Nm)	15.00
Tstart / Tnominal	3.50
Istart / Inominal	9.50
Tmax / Tnominal	3.00
Noise (dB)	64
PTC Thermistor	PTC 130
Weight (Kg)	26
DE Bearing	6206 2RZ C3
NDE Bearing	6206 2RZ C3