

Technical Datasheet

BERNATI

BMT Series - Aluminum frame three phase low voltage electric motor

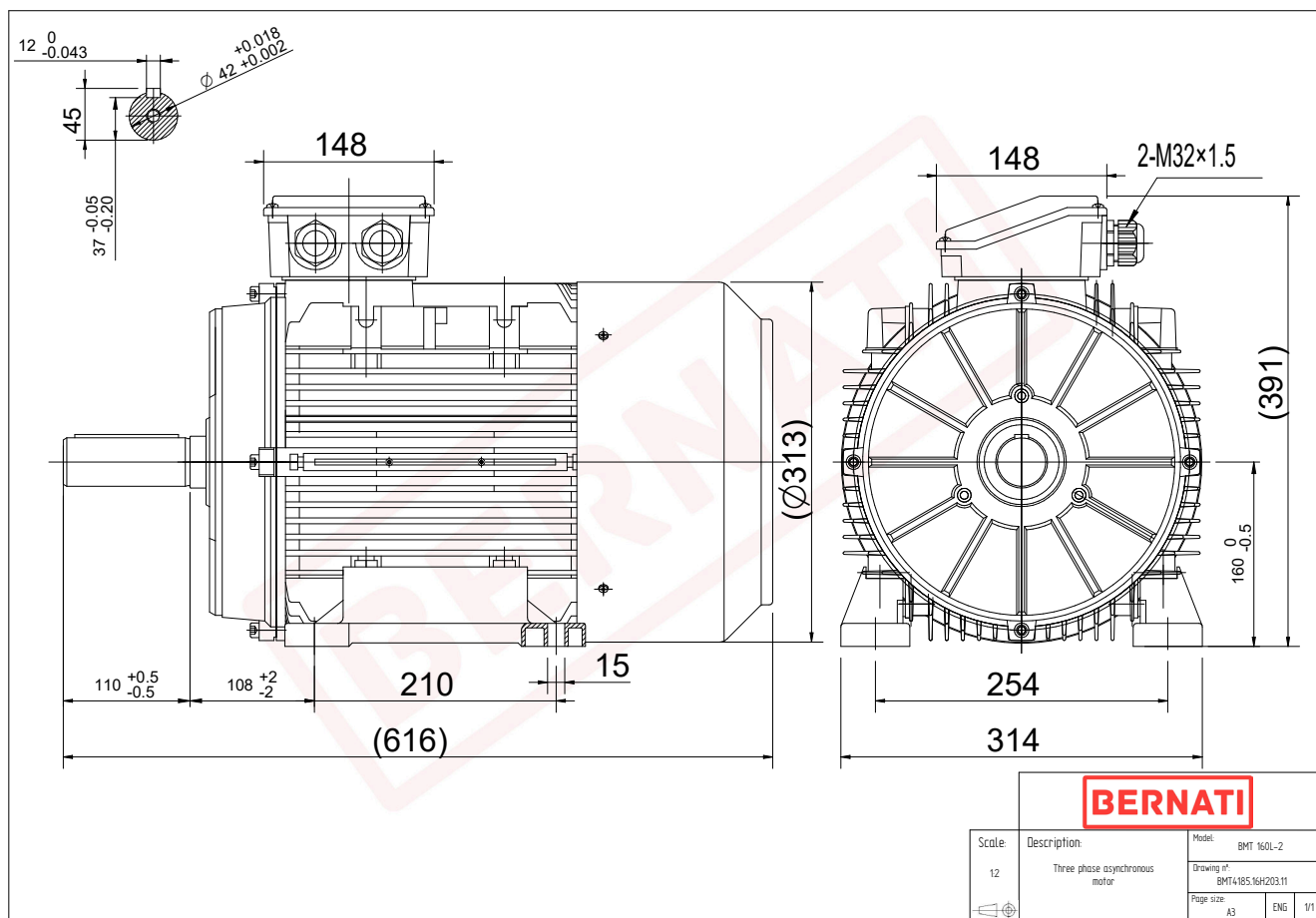

BMT	
Product Code	BMT4185.16H203.11
Motor Type/Frame	BMT 160L-2
Mounting	IM B3
Efficiency Class	IE4
Output Power (kW)	18.50
Speed (rpm)	2960
Tension (V)	230/400
Frequency (Hz)	50
Current (A)	30.60
Power factor (Cos Ø)	0.90
Poles	2
Insulation Class	F
IP Class	IP55
50% Efficiency	93.1
75% Efficiency	94.2
100% Efficiency	93.7
Torque (Nm)	62.20
Tstart / Tnominal	3.80
Istart / Inominal	10.30
Tmax / Tnominal	2.50
Noise (dB)	86
PTC Thermistor	PTC 130
Weight (Kg)	136
DE Bearing	6309 2RZ C3
NDE Bearing	6209 2RZ C3