

Technical Datasheet

BERNATI

BMT Series - Aluminum frame three phase low voltage electric motor

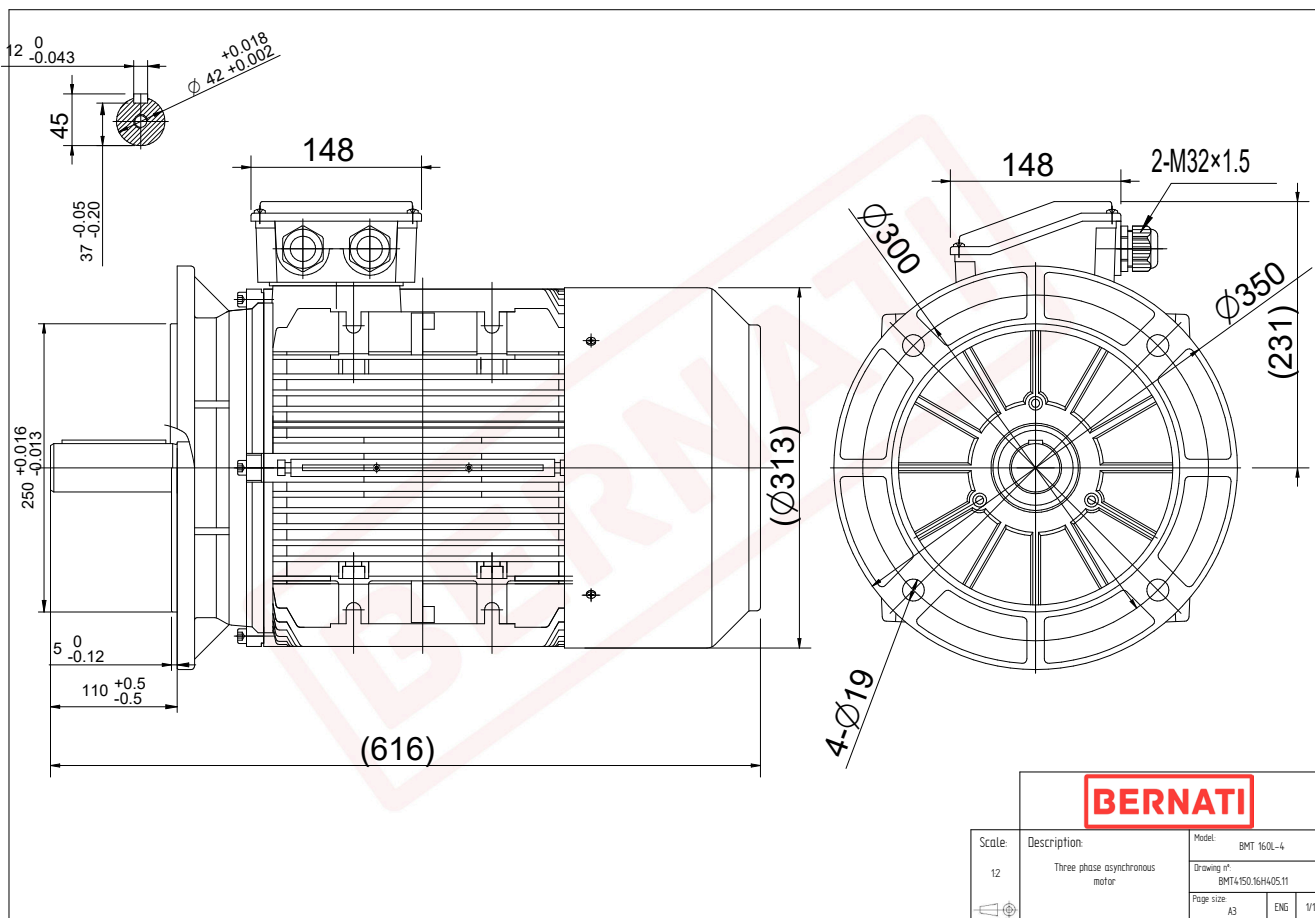

BMT

Product Code	BMT4150.16H405.11
Motor Type/Frame	BMT 160L-4
Mounting	IM B5
Efficiency Class	IE4
Output Power (kW)	15.00
Speed (rpm)	1475
Tension (V)	230/400
Frequency (Hz)	50
Current (A)	27.90
Power factor (Cos Ø)	0.80
Poles	4
Insulation Class	F
IP Class	IP55
50% Efficiency	93.7
75% Efficiency	94.1
100% Efficiency	93.9
Torque (Nm)	101.20
Tstart / Tnominal	3.20
Istart / Inominal	9.20
Tmax / Tnominal	2.20
Noise (dB)	75
PTC Thermistor	PTC 130
Weight (Kg)	126
DE Bearing	6309 2RZ C3
NDE Bearing	6209 2RZ C3