

Technical Datasheet

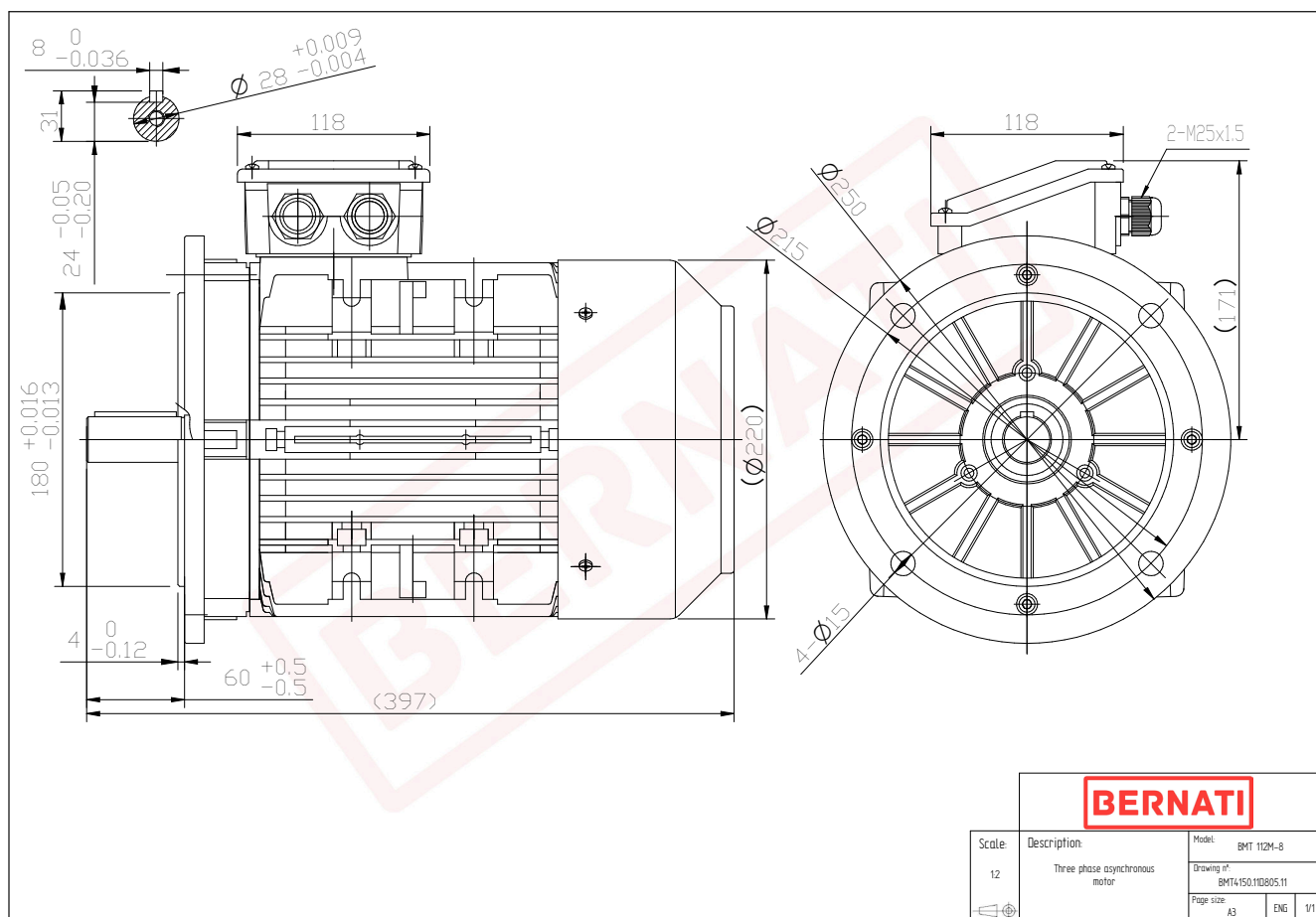

BMT Series - Aluminum frame three phase low voltage electric motor



BMT	
Product Code	BMT4150.11D805.11
Motor Type/Frame	BMT 112M-8
Mounting	IM B5
Efficiency Class	IE4
Output Power (kW)	1.50
Speed (rpm)	715
Tension (V)	230/400
Frequency (Hz)	50
Current (A)	4.20
Power factor (Cos Ø)	0.60
Poles	8
Insulation Class	F
IP Class	IP55
50% Efficiency	79.5
75% Efficiency	82.3
100% Efficiency	82.6
Torque (Nm)	20.90
Tstart / Tnominal	2.50
Istart / Inominal	5.10
Tmax / Tnominal	2.30
Noise (dB)	61
PTC Thermistor	PTC 130
Weight (Kg)	33
DE Bearing	6306 2RZ C3
NDE Bearing	6206 2RZ C3