

Technical Datasheet

BERNATI

BMT Series - Aluminum frame three phase low voltage electric motor

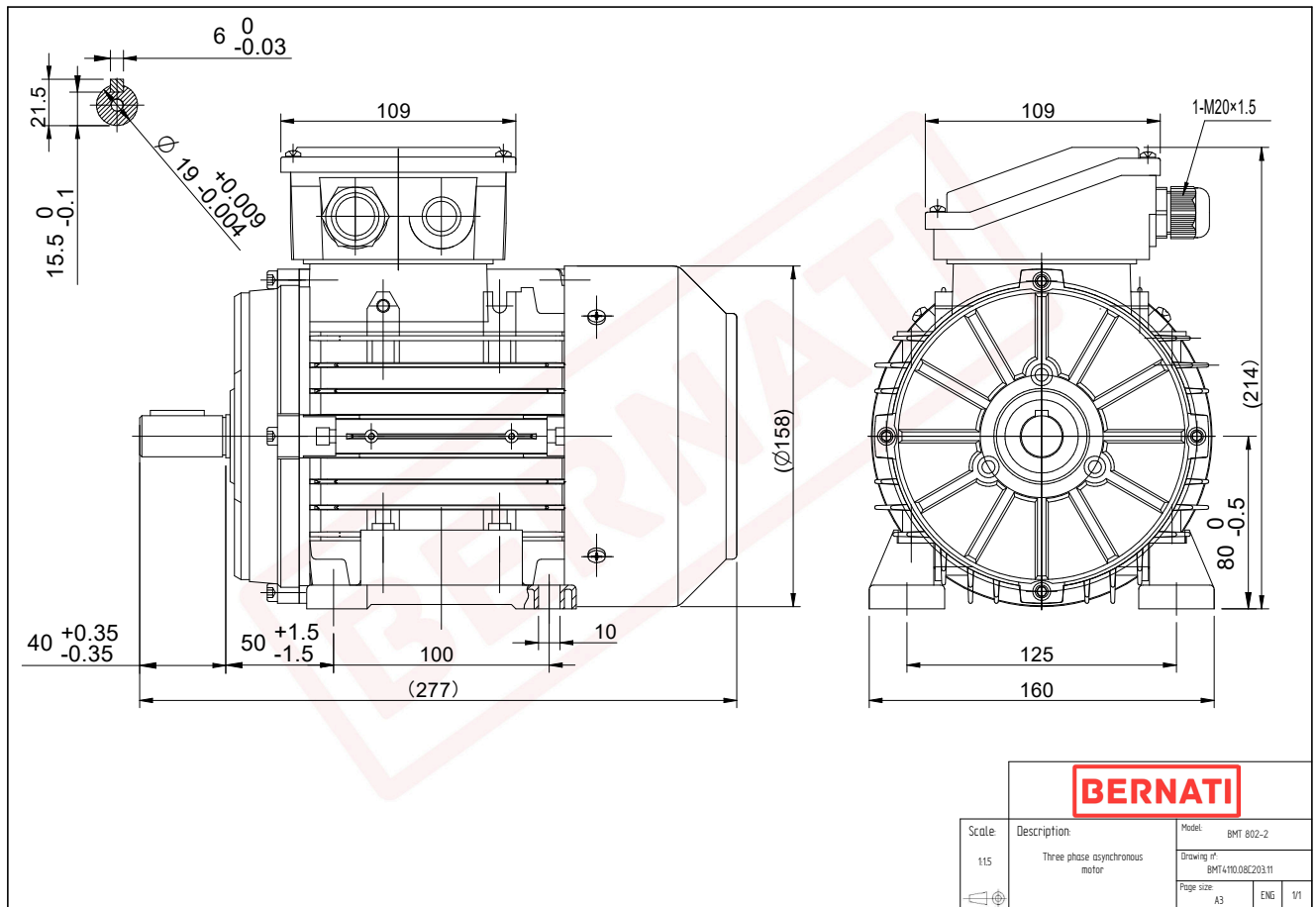

BMT	
Product Code	BMT4110.08C203.11
Motor Type/Frame	BMT 802-2
Mounting	IM B3
Efficiency Class	IE4
Output Power (kW)	1.10
Speed (rpm)	2910
Tension (V)	230/400
Frequency (Hz)	50
Current (A)	2.30
Power factor (Cos Ø)	0.80
Poles	2
Insulation Class	F
IP Class	IP55
50% Efficiency	83.3
75% Efficiency	85.2
100% Efficiency	85.2
Torque (Nm)	3.80
Tstart / Tnominal	4.00
Istart / Inominal	10.00
Tmax / Tnominal	4.20
Noise (dB)	67
PTC Thermistor	PTC 130
Weight (Kg)	12
DE Bearing	6204 2RZ C3
NDE Bearing	6204 2RZ C3