

Technical Datasheet

BERNATI

BMT Series - Aluminum frame three phase low voltage electric motor

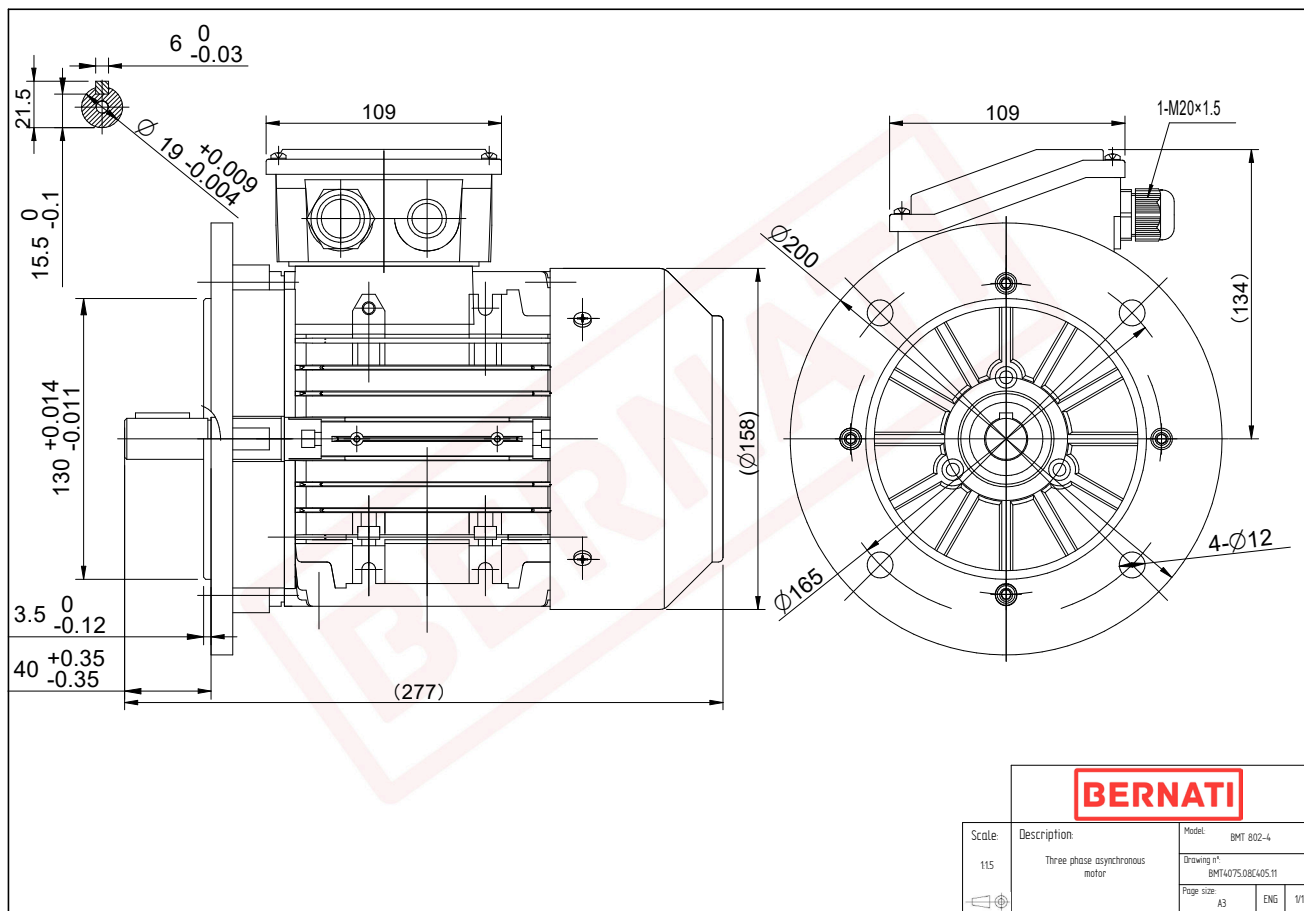

BMT

Product Code	BMT4075.08C405.11
Motor Type/Frame	BMT 802-4
Mounting	IM B5
Efficiency Class	IE4
Output Power (kW)	0.75
Speed (rpm)	1450
Tension (V)	230/400
Frequency (Hz)	50
Current (A)	2.00
Power factor (Cos Ø)	0.70
Poles	4
Insulation Class	F
IP Class	IP55
50% Efficiency	82.8
75% Efficiency	85.3
100% Efficiency	85.7
Torque (Nm)	5.20
Tstart / Tnominal	3.70
Istart / Inominal	7.30
Tmax / Tnominal	4.00
Noise (dB)	58
PTC Thermistor	PTC 130
Weight (Kg)	13
DE Bearing	6204 2RZ C3
NDE Bearing	6204 2RZ C3