

Technical Datasheet

BERNATI

BMT Series - Aluminum frame three phase low voltage electric motor

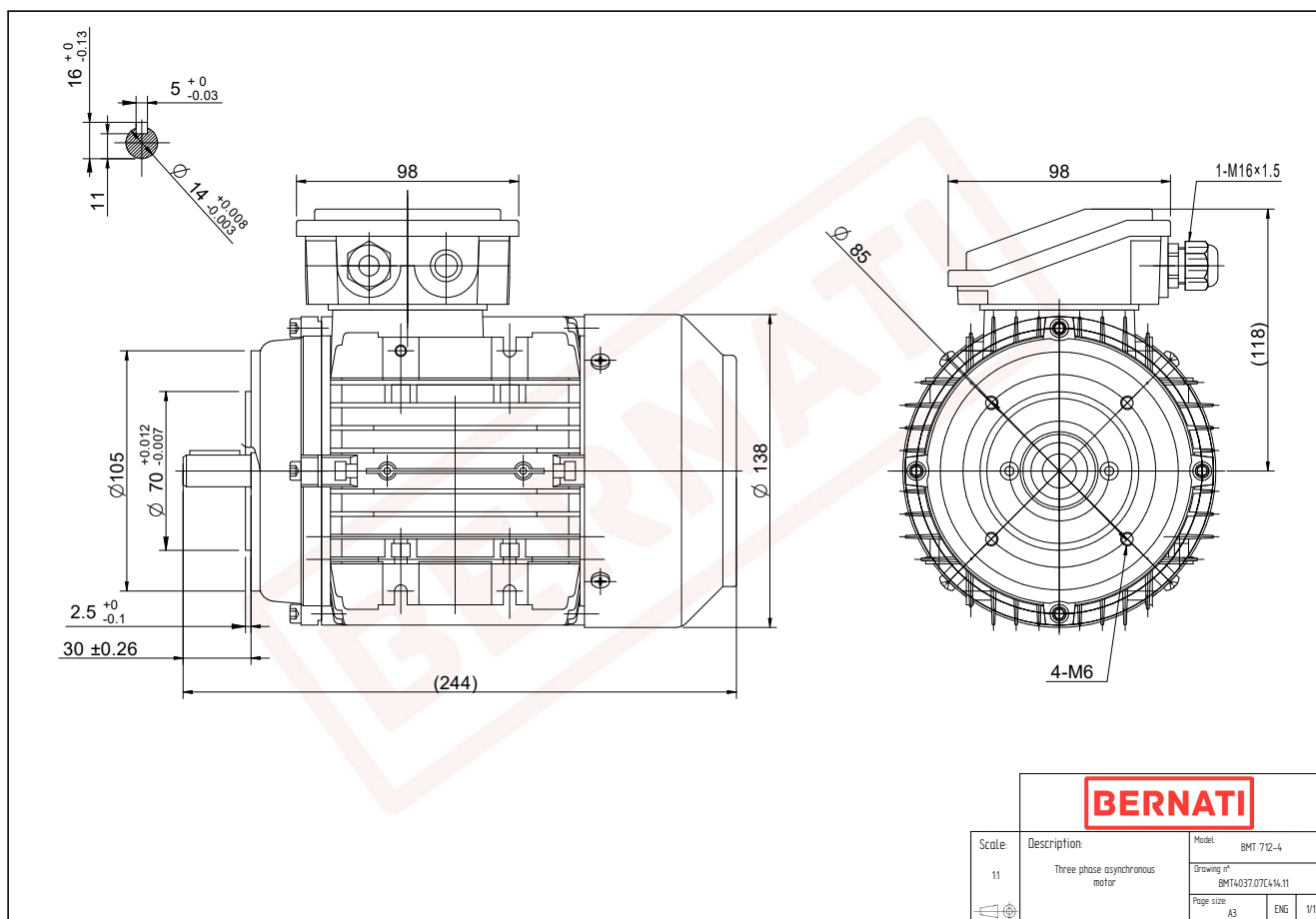

BMT	
Product Code	BMT4037.07C414.11
Motor Type/Frame	BMT 712-4
Mounting	IM B14
Efficiency Class	IE4
Output Power (kW)	0.37
Speed (rpm)	1430
Tension (V)	230/400
Frequency (Hz)	50
Current (A)	1.00
Power factor (Cos Ø)	0.70
Poles	4
Insulation Class	F
IP Class	IP55
50% Efficiency	77.2
75% Efficiency	80.5
100% Efficiency	81.1
Torque (Nm)	2.60
Tstart / Tnominal	3.40
Istart / Inominal	6.20
Tmax / Tnominal	3.60
Noise (dB)	55
PTC Thermistor	PTC 130
Weight (Kg)	8
DE Bearing	6202 2RZ C3
NDE Bearing	6202 2RZ C3