

Technical Datasheet

BERNATI

BMT Series - Aluminum frame three phase low voltage electric motor

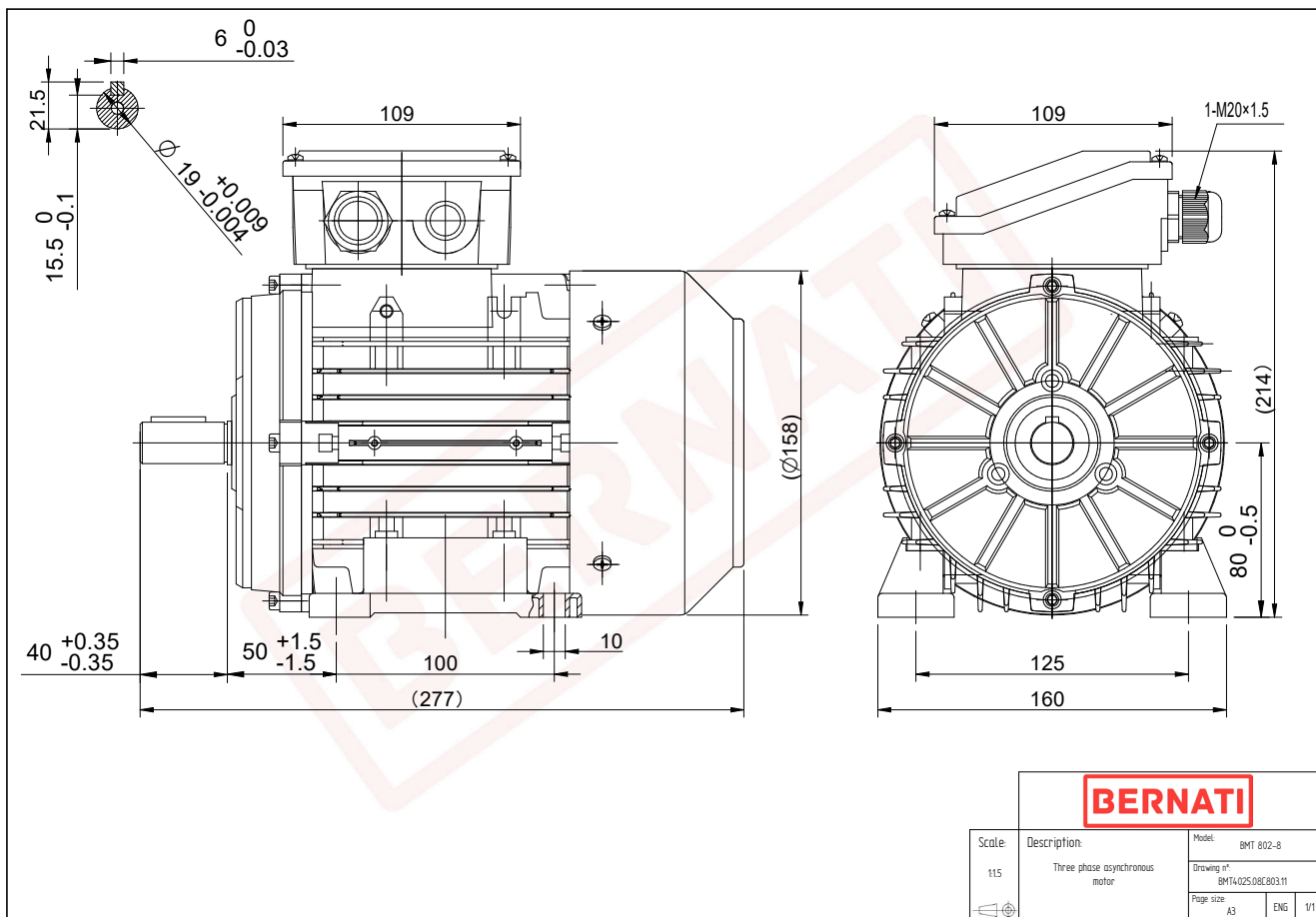

BMT	
Product Code	BMT4025.08C803.11
Motor Type/Frame	BMT 802-8
Mounting	IM B3
Efficiency Class	IE4
Output Power (kW)	0.25
Speed (rpm)	710
Tension (V)	230/400
Frequency (Hz)	50
Current (A)	1.10
Power factor (Cos Ø)	0.50
Poles	8
Insulation Class	F
IP Class	IP55
50% Efficiency	61.0
75% Efficiency	67.9
100% Efficiency	70.8
Torque (Nm)	3.50
Tstart / Tnominal	2.70
Istart / Inominal	3.70
Tmax / Tnominal	3.10
Noise (dB)	52
PTC Thermistor	PTC 130
Weight (Kg)	12
DE Bearing	6204 2RZ C3
NDE Bearing	6204 2RZ C3