

Technical Datasheet

BERNATI

BMT Series - Aluminum frame three phase low voltage electric motor

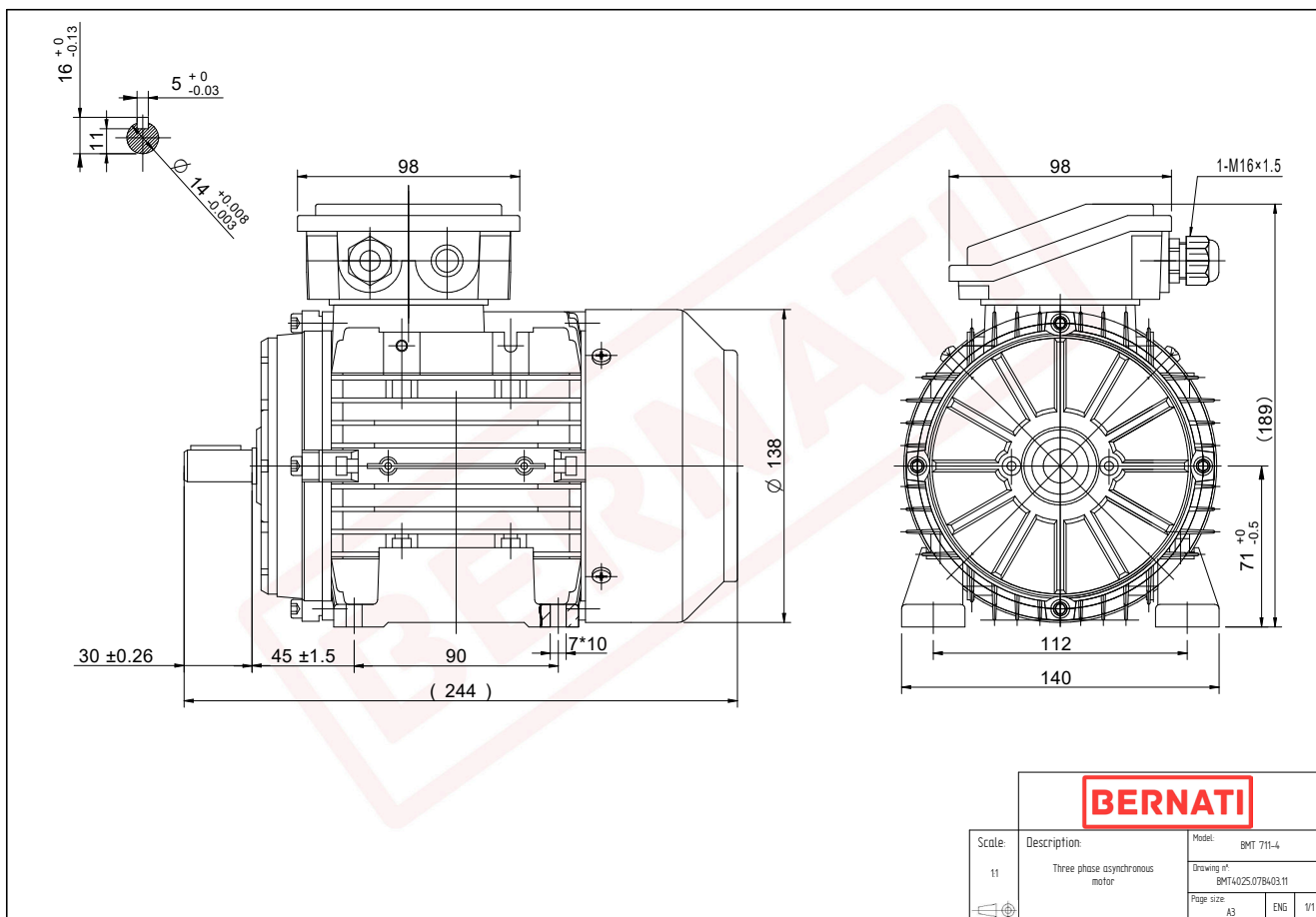

BMT	
Product Code	BMT4025.07B403.11
Motor Type/Frame	BMT 711-4
Mounting	IM B3
Efficiency Class	IE4
Output Power (kW)	0.25
Speed (rpm)	1430
Tension (V)	230/400
Frequency (Hz)	50
Current (A)	0.70
Power factor (Cos Ø)	0.70
Poles	4
Insulation Class	F
IP Class	IP55
50% Efficiency	72.9
75% Efficiency	77.0
100% Efficiency	77.9
Torque (Nm)	1.70
Tstart / Tnominal	3.00
Istart / Inominal	5.60
Tmax / Tnominal	3.40
Noise (dB)	55
PTC Thermistor	PTC 130
Weight (Kg)	7
DE Bearing	6202 2RZ C3
NDE Bearing	6202 2RZ C3