

# Technical Datasheet

**BERNATI**

BMT Series - Aluminum frame three phase low voltage electric motor

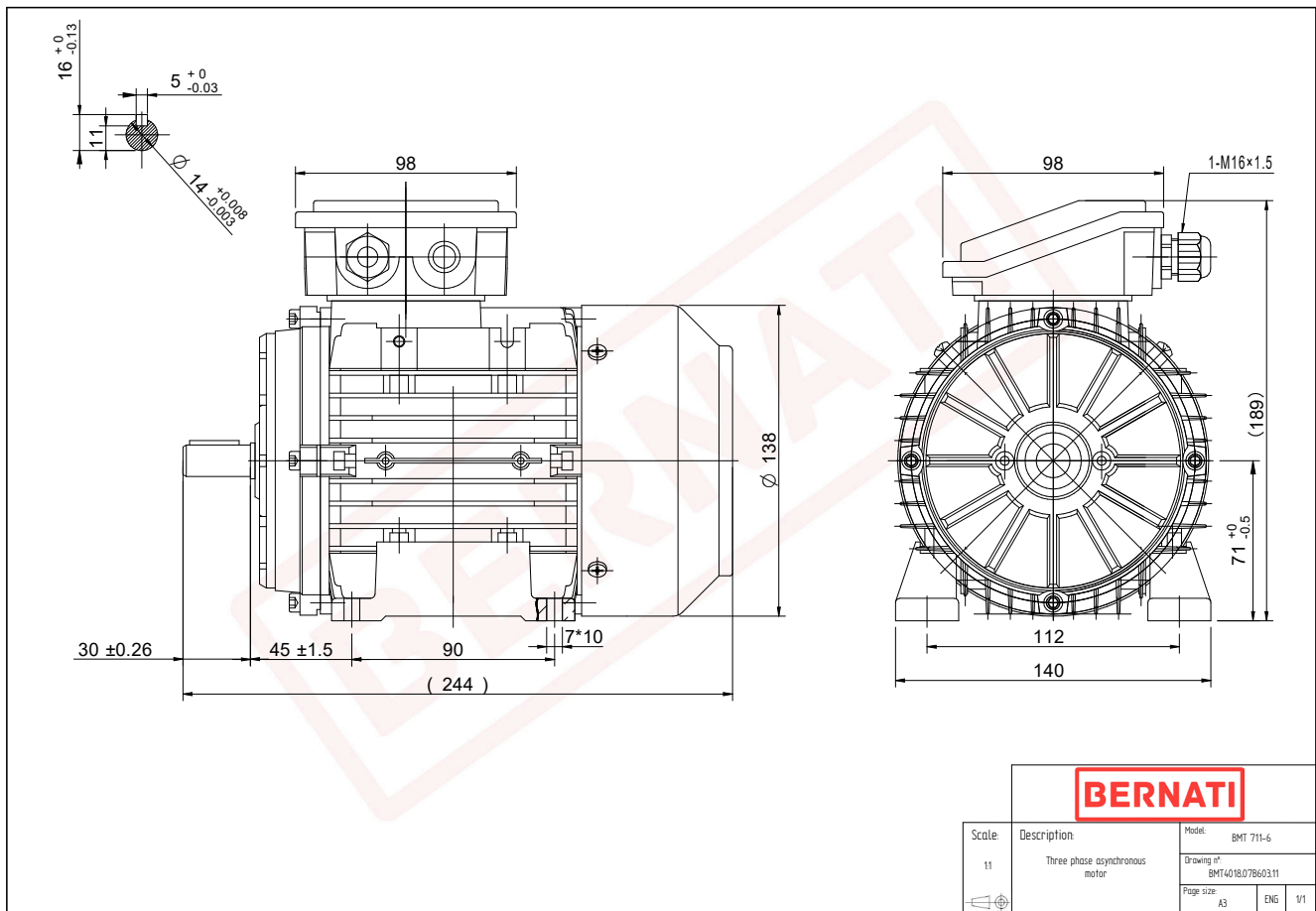

<b>BMT</b>	
Product Code	BMT4018.07B603.11
Motor Type/Frame	BMT 711-6
Mounting	IM B3
Efficiency Class	IE4
Output Power (kW)	0.18
Speed (rpm)	940
Tension (V)	230/400
Frequency (Hz)	50
Current (A)	0.60
Power factor (Cos Ø)	0.60
Poles	6
Insulation Class	F
IP Class	IP55
50% Efficiency	60.2
75% Efficiency	66.8
100% Efficiency	70.1
Torque (Nm)	1.90
Tstart / Tnominal	2.70
Istart / Inominal	4.10
Tmax / Tnominal	2.30
Noise (dB)	52
PTC Thermistor	PTC 130
Weight (Kg)	6
DE Bearing	6202 2RZ C3
NDE Bearing	6202 2RZ C3