

Technical Datasheet

BERNATI

BMT Series - Aluminum frame three phase low voltage electric motor

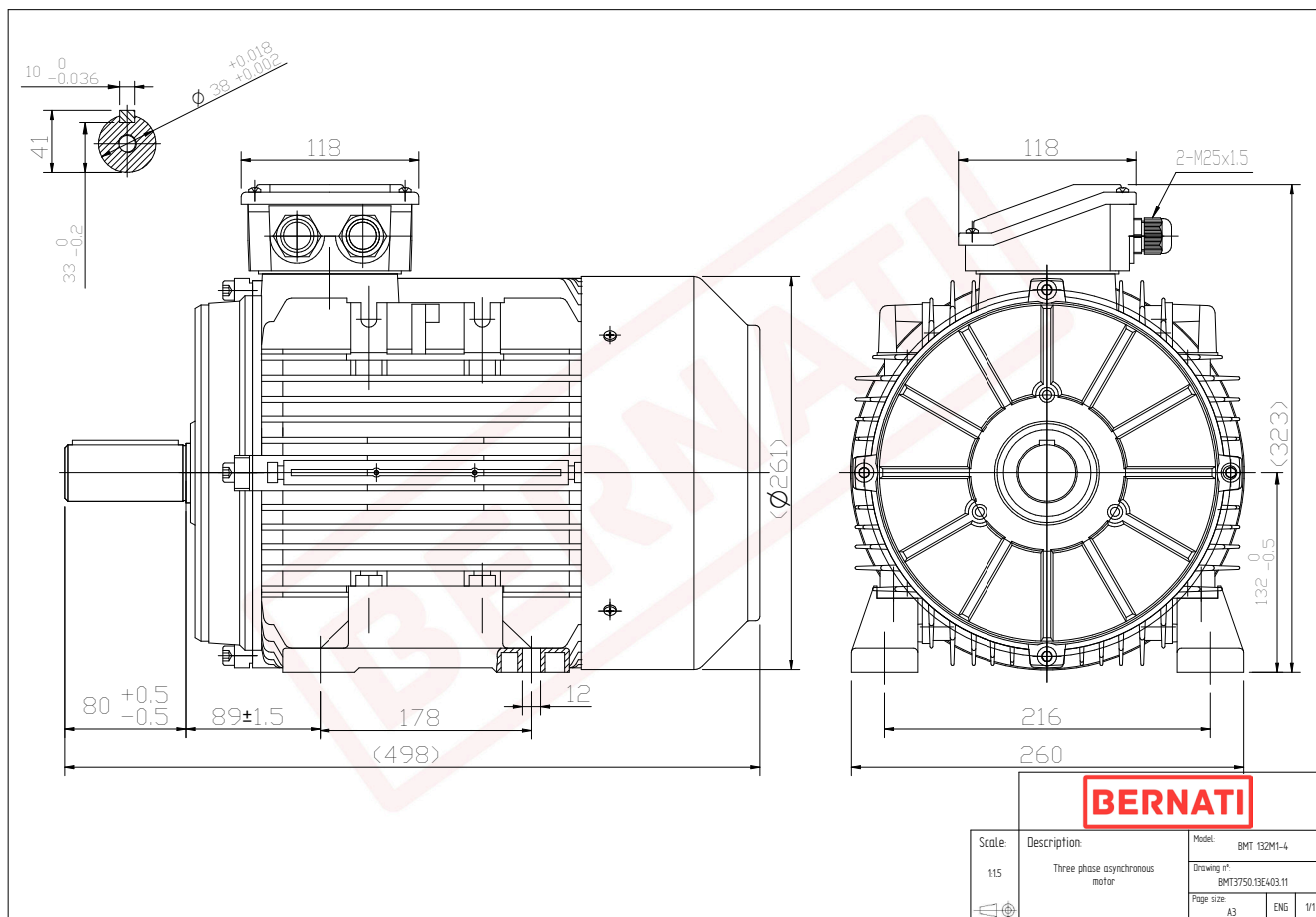

BMT	
Product Code	BMT3750.13E403.111
Motor Type/Frame	BMT 132M1-4
Mounting	IM B3
Efficiency Class	IE3
Output Power (kW)	7.50
Speed (rpm)	1460
Tension (V)	230/400
Frequency (Hz)	50
Current (A)	14.26
Power factor (Cos Ø)	0.84
Poles	4
Insulation Class	F
IP Class	IP55
50% Efficiency	90.3
75% Efficiency	90.9
100% Efficiency	90.4
Torque (Nm)	49.06
Tstart / Tnominal	2.60
Istart / Inominal	8.90
Tmax / Tnominal	3.40
Noise (dB)	71
PTC Thermistor	PTC 130
Weight (Kg)	57
DE Bearing	6308 2RZ C3
NDE Bearing	6208 2RZ C3