

Technical Datasheet

BERNATI

BMT Series - Aluminum frame three phase low voltage electric motor

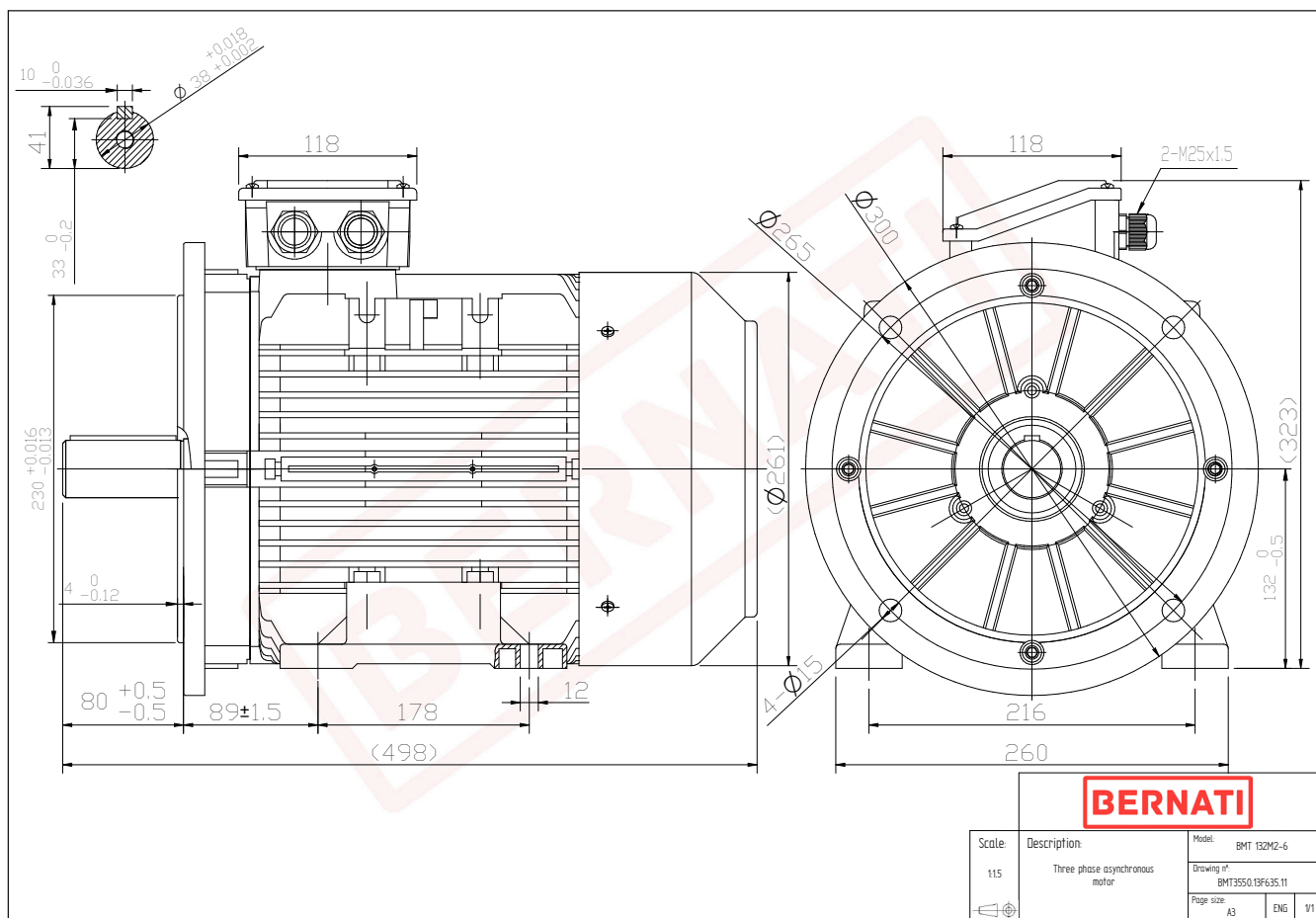

BMT

Product Code	BMT3550.13F635.11
Motor Type/Frame	BMT 132M2-6
Mounting	IM B3/B5
Efficiency Class	IE3
Output Power (kW)	5.50
Speed (rpm)	975
Tension (V)	230/400
Frequency (Hz)	50
Current (A)	12.71
Power factor (Cos Ø)	0.71
Poles	6
Insulation Class	F
IP Class	IP55
50% Efficiency	87.1
75% Efficiency	88.3
100% Efficiency	88.0
Torque (Nm)	53.87
Tstart / Tnominal	2.90
Istart / Inominal	7.40
Tmax / Tnominal	3.50
Noise (dB)	68
PTC Thermistor	PTC 130
Weight (Kg)	56
DE Bearing	6308 2RZ C3
NDE Bearing	6208 2RZ C3