

Technical Datasheet

BERNATI

BMT Series - Aluminum frame three phase low voltage electric motor

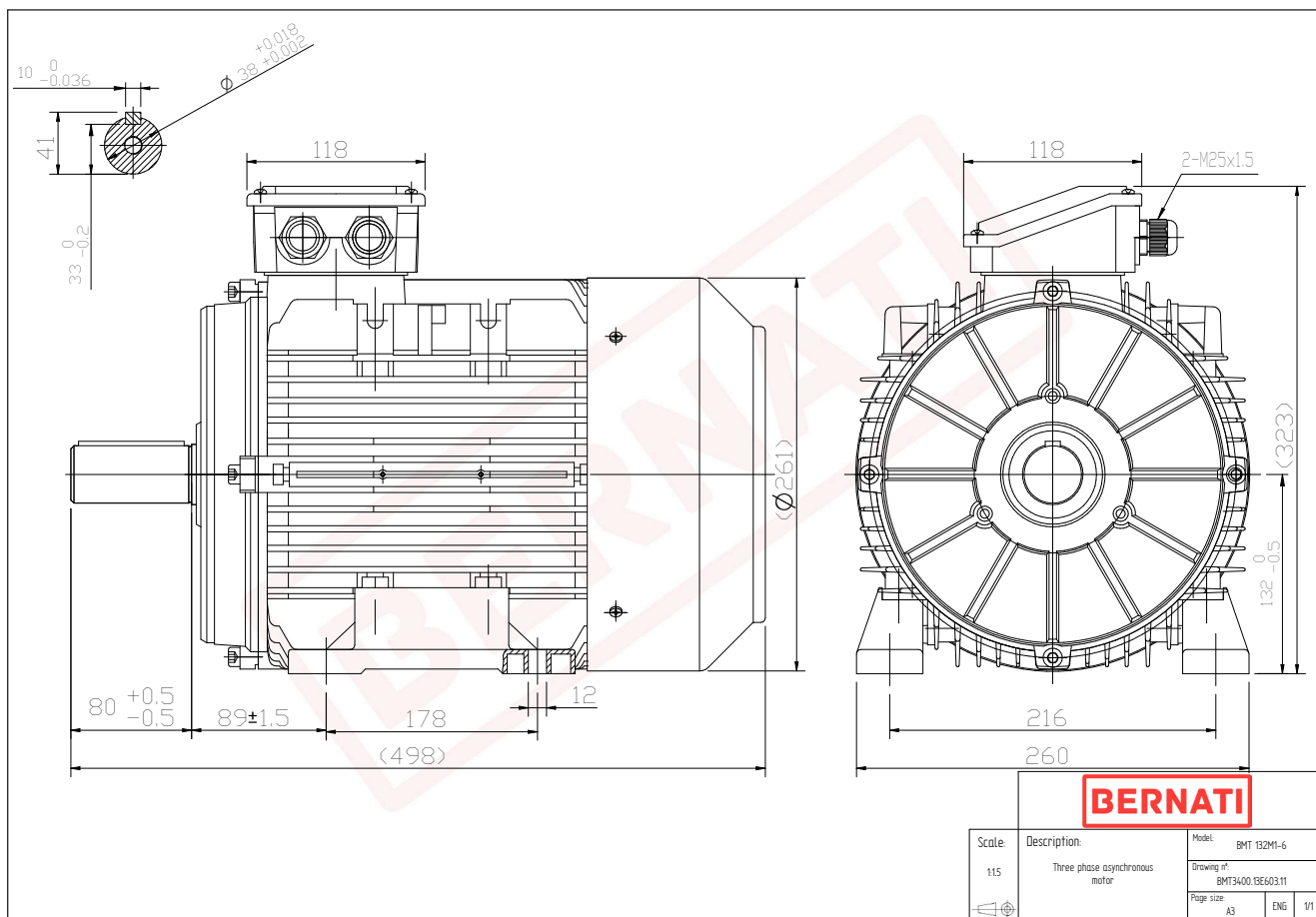

BMT	
Product Code	BMT3400.13E603.11
Motor Type/Frame	BMT 132M1-6
Mounting	IM B3
Efficiency Class	IE3
Output Power (kW)	4.00
Speed (rpm)	870
Tension (V)	230/400
Frequency (Hz)	50
Current (A)	8.99
Power factor (Cos Ø)	0.74
Poles	6
Insulation Class	F
IP Class	IP55
50% Efficiency	86.2
75% Efficiency	87.1
100% Efficiency	86.8
Torque (Nm)	39.38
Tstart / Tnominal	2.30
Istart / Inominal	6.80
Tmax / Tnominal	3.00
Noise (dB)	68
PTC Thermistor	PTC 130
Weight (Kg)	48
DE Bearing	6308 2RZ C3
NDE Bearing	6208 2RZ C3