

Technical Datasheet

BERNATI

BMT Series - Aluminum frame three phase low voltage electric motor

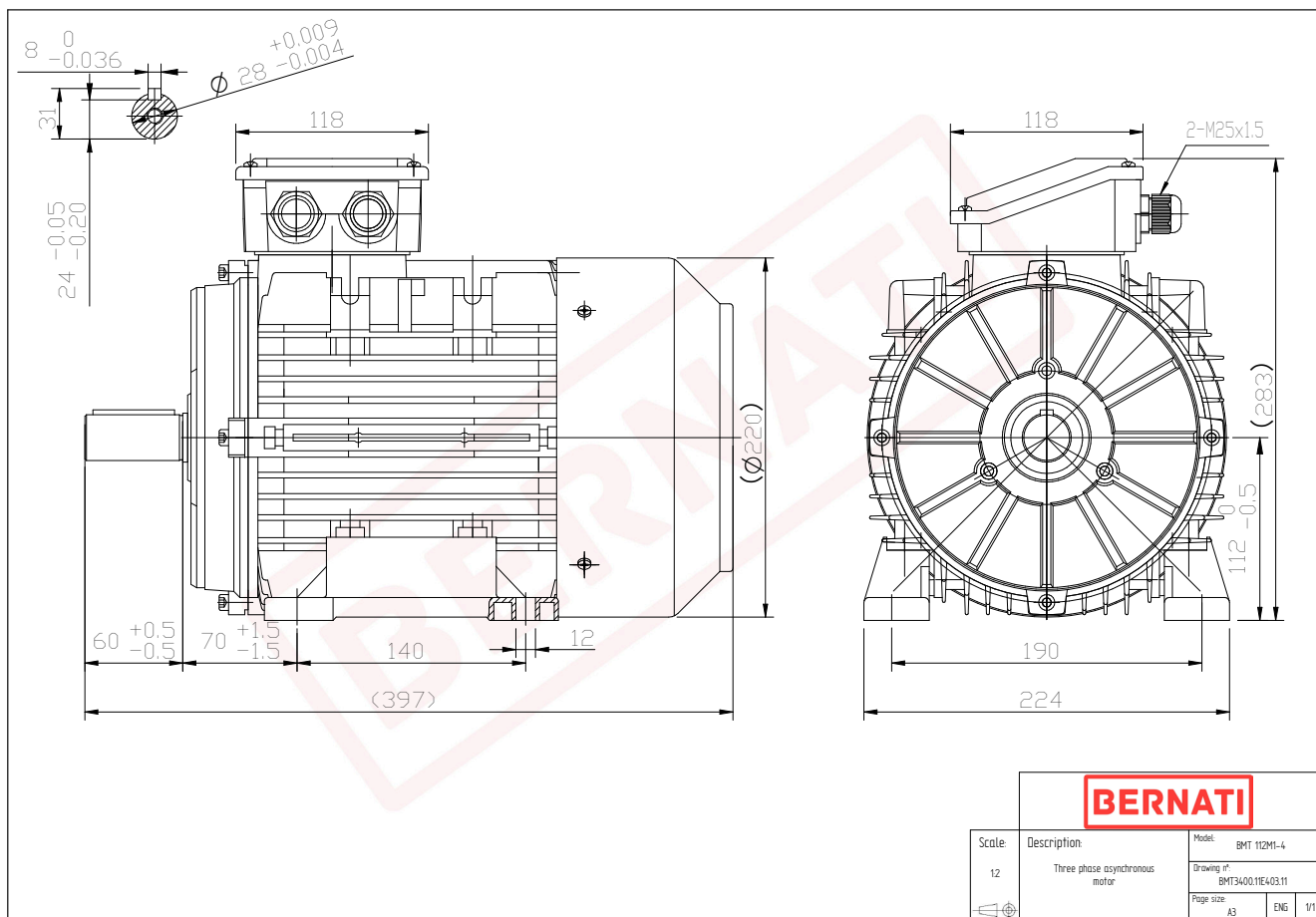

BMT	
Product Code	BMT3400.11E403.11
Motor Type/Frame	BMT 112M1-4
Mounting	IM B3
Efficiency Class	IE3
Output Power (kW)	4.00
Speed (rpm)	1450
Tension (V)	230/400
Frequency (Hz)	50
Current (A)	7.95
Power factor (Cos Ø)	0.82
Poles	4
Insulation Class	F
IP Class	IP55
50% Efficiency	88.2
75% Efficiency	88.8
100% Efficiency	88.6
Torque (Nm)	26.34
Tstart / Tnominal	3.10
Istart / Inominal	8.60
Tmax / Tnominal	3.70
Noise (dB)	65
PTC Thermistor	PTC 130
Weight (Kg)	34
DE Bearing	6306 2RZ C3
NDE Bearing	6206 2RZ C3