

Technical Datasheet

BERNATI

BMT Series - Aluminum frame three phase low voltage electric motor

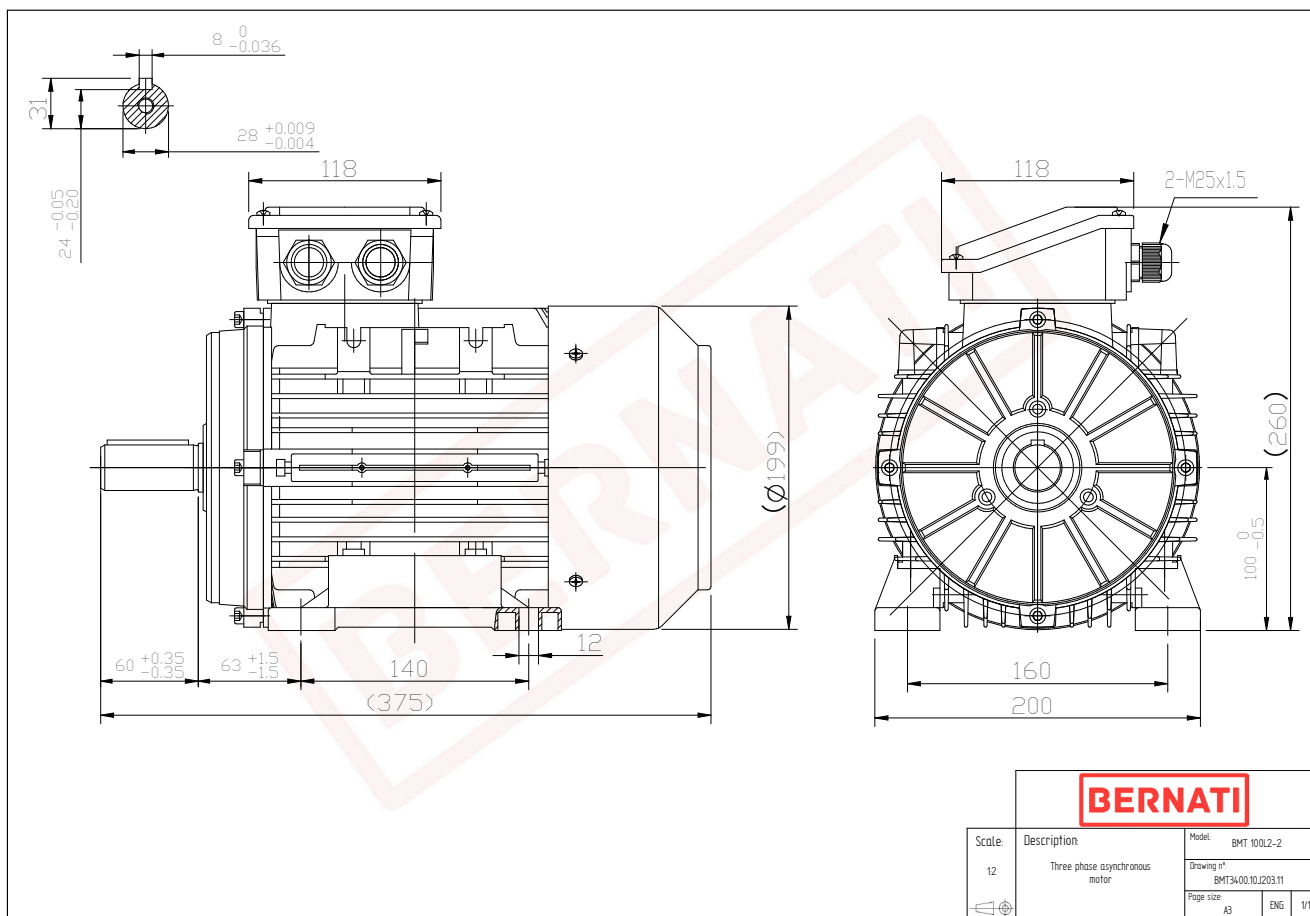

BMT	
Product Code	BMT3400.10J203.11
Motor Type/Frame	BMT 100L2-2
Mounting	IM B3
Efficiency Class	IE3
Output Power (kW)	4.00
Speed (rpm)	2910
Tension (V)	230/400
Frequency (Hz)	50
Current (A)	7.12
Power factor (Cos Ø)	0.92
Poles	2
Insulation Class	F
IP Class	IP55
50% Efficiency	88.1
75% Efficiency	88.8
100% Efficiency	88.1
Torque (Nm)	13.13
Tstart / Tnominal	2.80
Istart / Inominal	9.10
Tmax / Tnominal	3.30
Noise (dB)	77
PTC Thermistor	PTC 130
Weight (Kg)	28
DE Bearing	6206 2RZ C3
NDE Bearing	6206 2RZ C3