

Technical Datasheet

BERNATI

BMT Series - Aluminum frame three phase low voltage electric motor

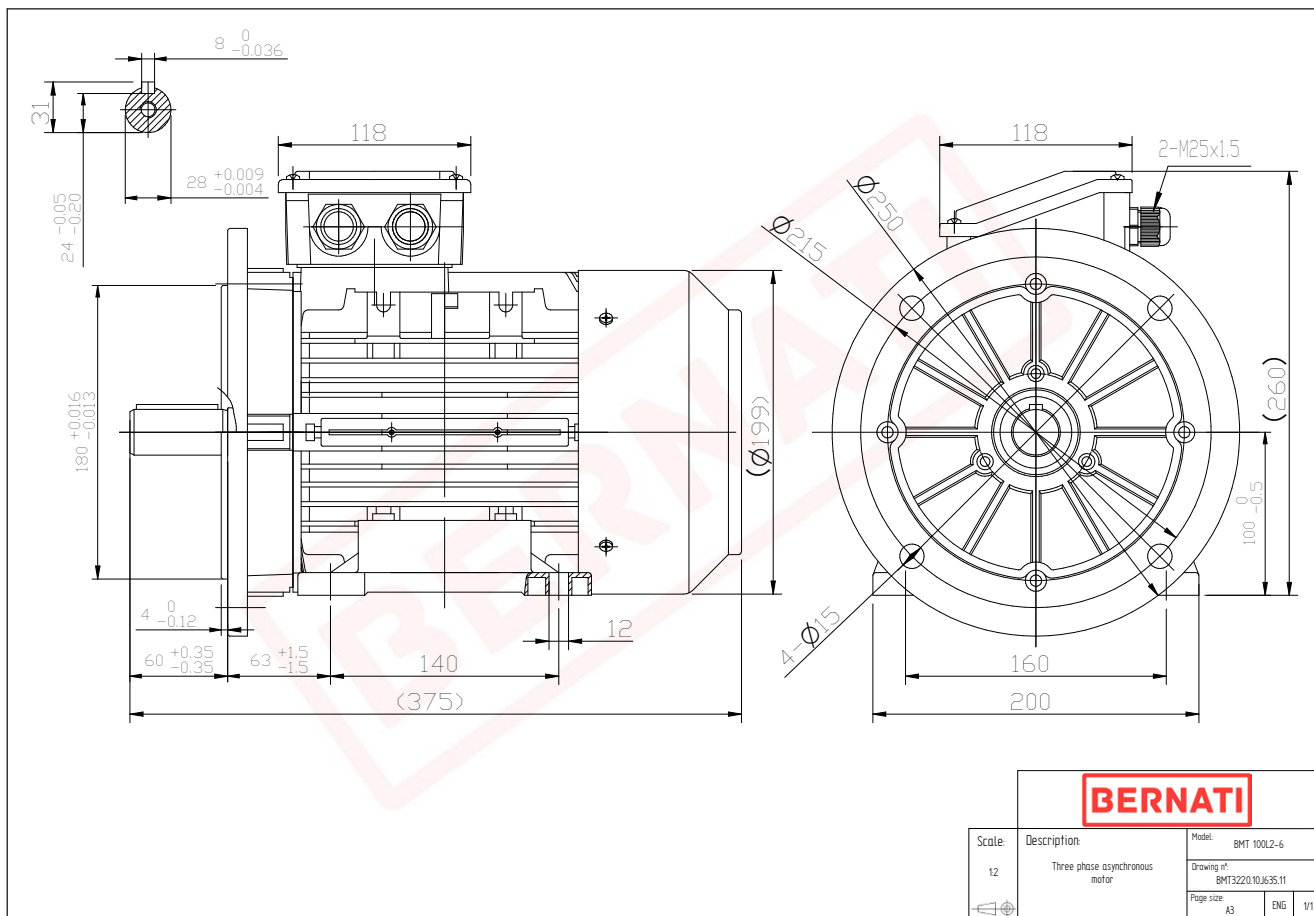

BMT	
Product Code	BMT3220.10J635.11
Motor Type/Frame	BMT 100L2-6
Mounting	IM B3/B5
Efficiency Class	IE3
Output Power (kW)	2.20
Speed (rpm)	955
Tension (V)	230/400
Frequency (Hz)	50
Current (A)	5.23
Power factor (Cos Ø)	0.72
Poles	6
Insulation Class	F
IP Class	IP55
50% Efficiency	83.9
75% Efficiency	85.1
100% Efficiency	84.3
Torque (Nm)	22.00
Tstart / Tnominal	2.50
Istart / Inominal	6.20
Tmax / Tnominal	3.00
Noise (dB)	64
PTC Thermistor	PTC 130
Weight (Kg)	28
DE Bearing	6206 2RZ C3
NDE Bearing	6206 2RZ C3