

Technical Datasheet

BERNATI

BMT Series - Aluminum frame three phase low voltage electric motor

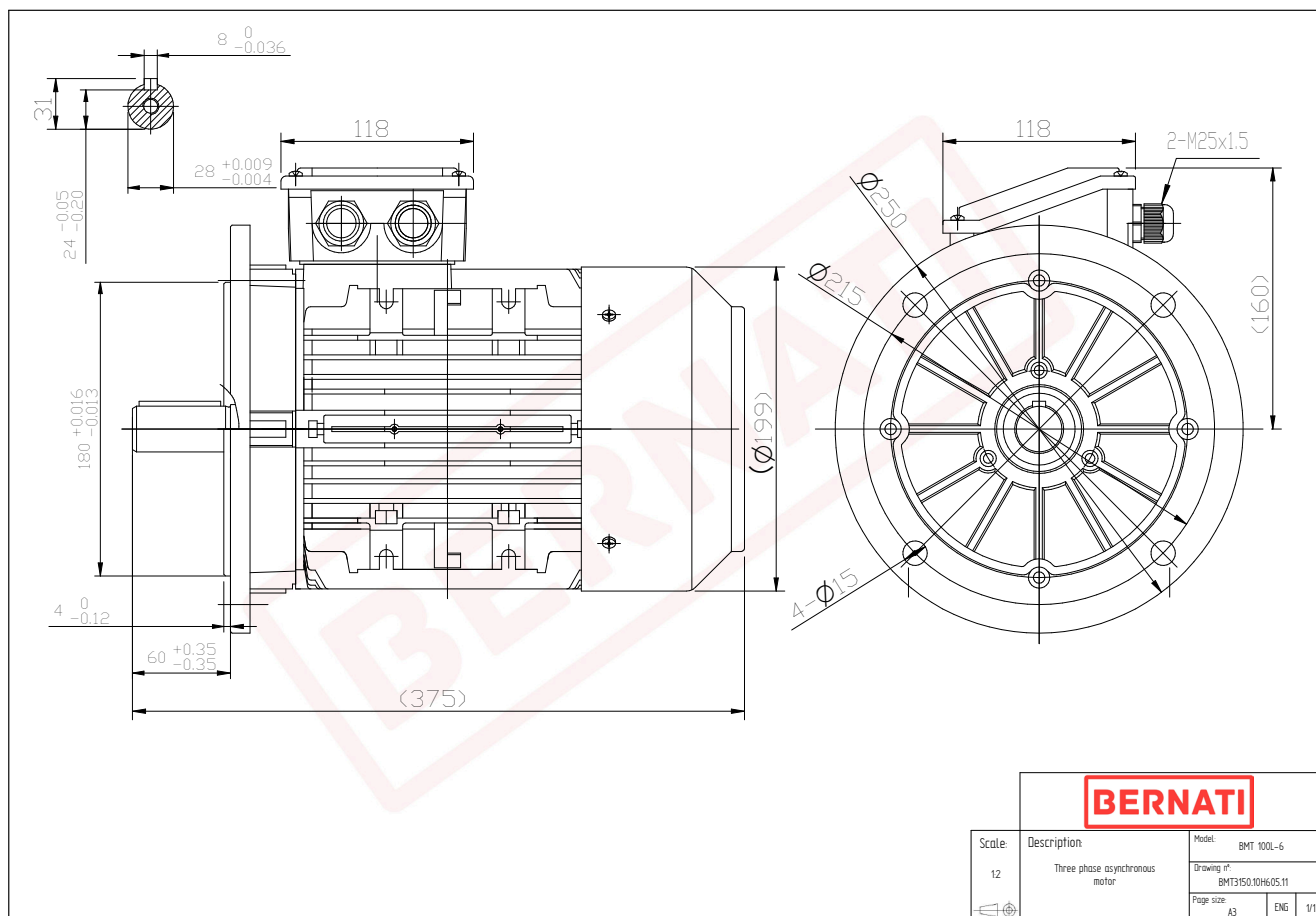

BMT

Product Code	BMT3150.10H605.11
Motor Type/Frame	BMT 100L-6
Mounting	IM B5
Efficiency Class	IE3
Output Power (kW)	1.50
Speed (rpm)	955
Tension (V)	230/400
Frequency (Hz)	50
Current (A)	3.75
Power factor (Cos Ø)	0.70
Poles	6
Insulation Class	F
IP Class	IP55
50% Efficiency	81.8
75% Efficiency	83.0
100% Efficiency	82.5
Torque (Nm)	15.00
Tstart / Tnominal	2.40
Istart / Inominal	5.50
Tmax / Tnominal	2.90
Noise (dB)	61
PTC Thermistor	PTC 130
Weight (Kg)	22
DE Bearing	6206 2RZ C3
NDE Bearing	6206 2RZ C3