

BMT Series - Aluminum frame three phase low voltage electric motor

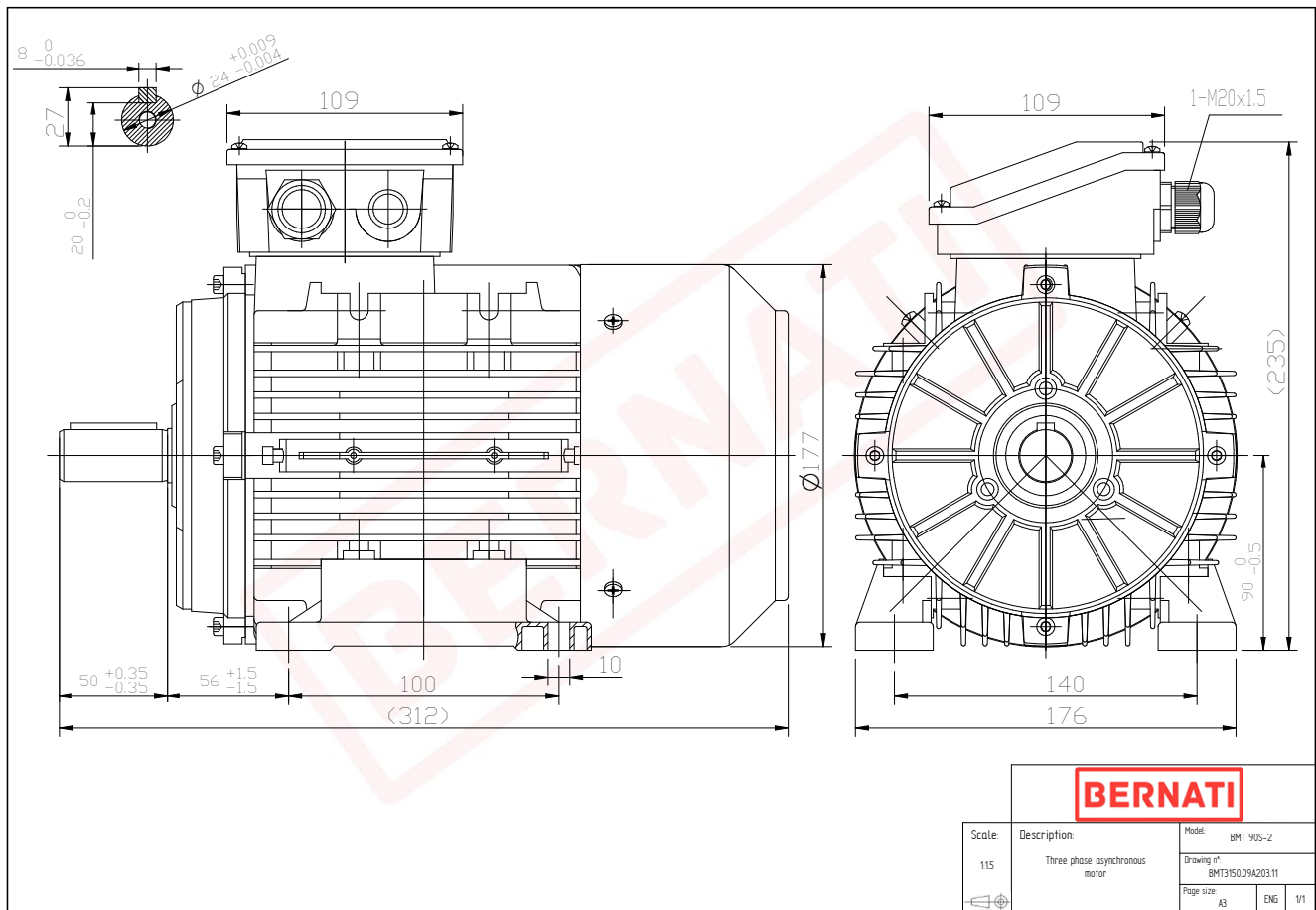

BMT

Product Code	BMT3150.09A203.11
Motor Type/Frame	BMT 90S-2
Mounting	IM B3
Efficiency Class	IE3
Output Power (kW)	1.50
Speed (rpm)	2900
Tension (V)	230/400
Frequency (Hz)	50
Current (A)	3.14
Power factor (Cos Ø)	0.82
Poles	2
Insulation Class	F
IP Class	IP55
50% Efficiency	81.4
75% Efficiency	83.8
100% Efficiency	84.2
Torque (Nm)	4.94
Tstart / Tnominal	3.50
Istart / Inominal	8.30
Tmax / Tnominal	3.70
Noise (dB)	72
PTC Thermistor	PTC 130
Weight (Kg)	14
DE Bearing	6205 2RZ C3
NDE Bearing	6205 2RZ C3