

Technical Datasheet

BERNATI

BMT Series - Aluminum frame three phase low voltage electric motor

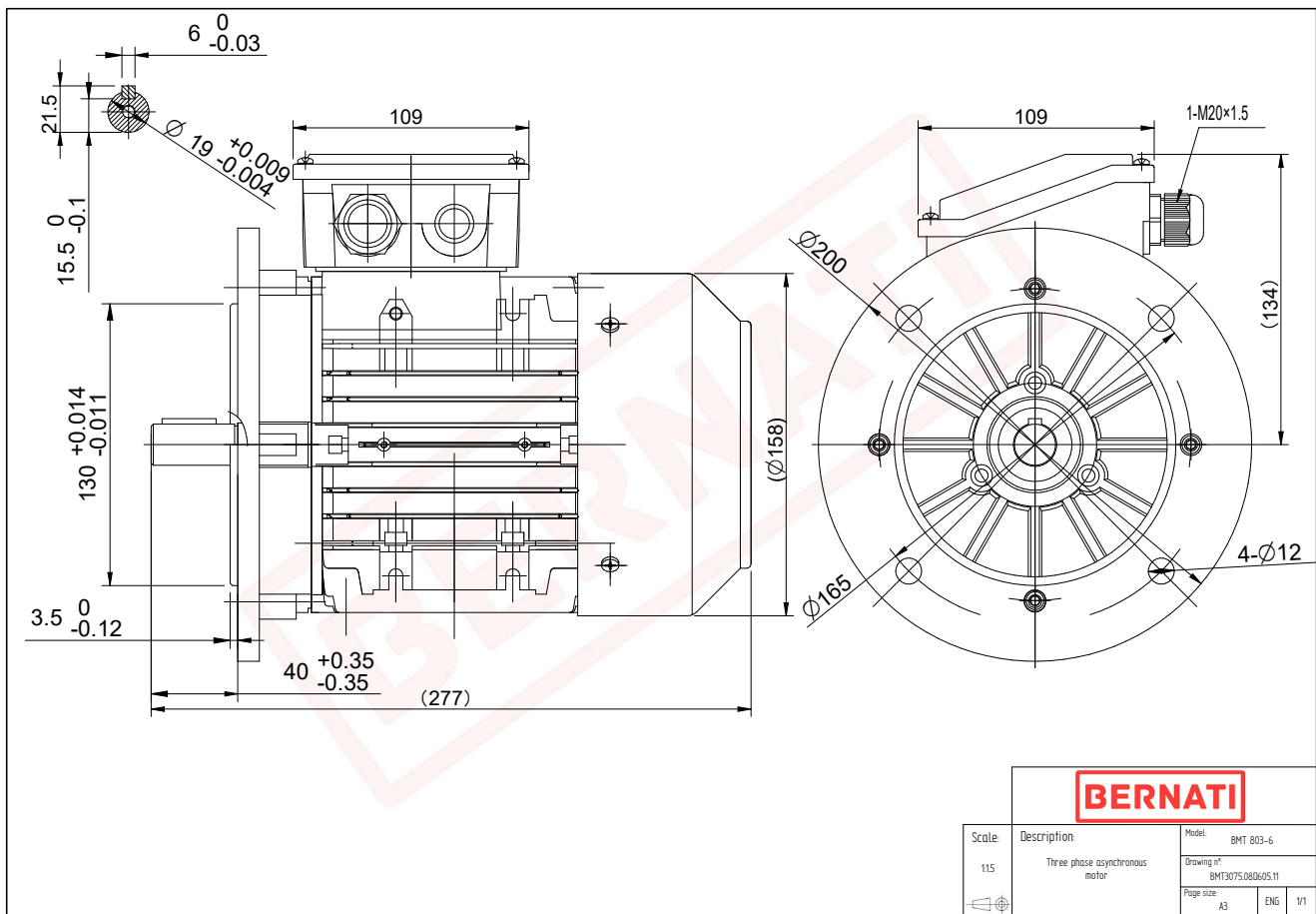

BMT	
Product Code	BMT3075.08D605.11
Motor Type/Frame	BMT 803-6
Mounting	IM B5
Efficiency Class	IE3
Output Power (kW)	0.75
Speed (rpm)	935
Tension (V)	230/400
Frequency (Hz)	50
Current (A)	2.18
Power factor (Cos Ø)	0.63
Poles	6
Insulation Class	F
IP Class	IP55
50% Efficiency	74.4
75% Efficiency	78.2
100% Efficiency	78.9
Torque (Nm)	7.66
Tstart / Tnominal	2.80
Istart / Inominal	4.90
Tmax / Tnominal	3.10
Noise (dB)	59
PTC Thermistor	PTC 130
Weight (Kg)	13
DE Bearing	6204 2RZ C3
NDE Bearing	6204 2RZ C3