

Technical Datasheet

BERNATI

BMT Series - Aluminum frame three phase low voltage electric motor

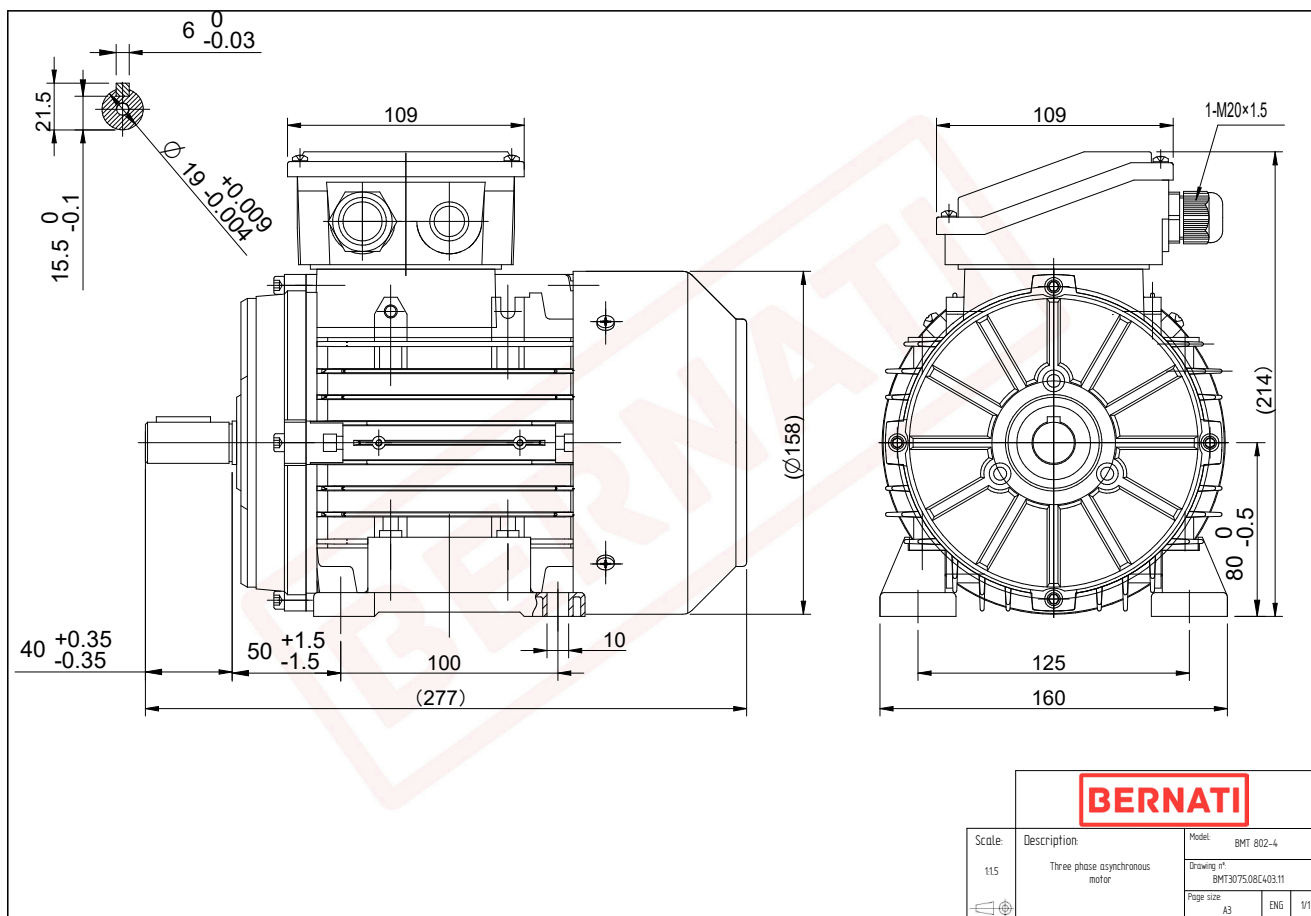

BMT

Product Code	BMT3075.08C403.11
Motor Type/Frame	BMT 802-4
Mounting	IM B3
Efficiency Class	IE3
Output Power (kW)	0.75
Speed (rpm)	1440
Tension (V)	230/400
Frequency (Hz)	50
Current (A)	1.90
Power factor (Cos Ø)	0.69
Poles	4
Insulation Class	F
IP Class	IP55
50% Efficiency	80.1
75% Efficiency	82.5
100% Efficiency	82.5
Torque (Nm)	4.97
Tstart / Tnominal	3.10
Istart / Inominal	6.30
Tmax / Tnominal	3.10
Noise (dB)	58
PTC Thermistor	PTC 130
Weight (Kg)	12
DE Bearing	6204 2RZ C3
NDE Bearing	6204 2RZ C3