

Technical Datasheet

BERNATI

BMT Series - Aluminum frame three phase low voltage electric motor

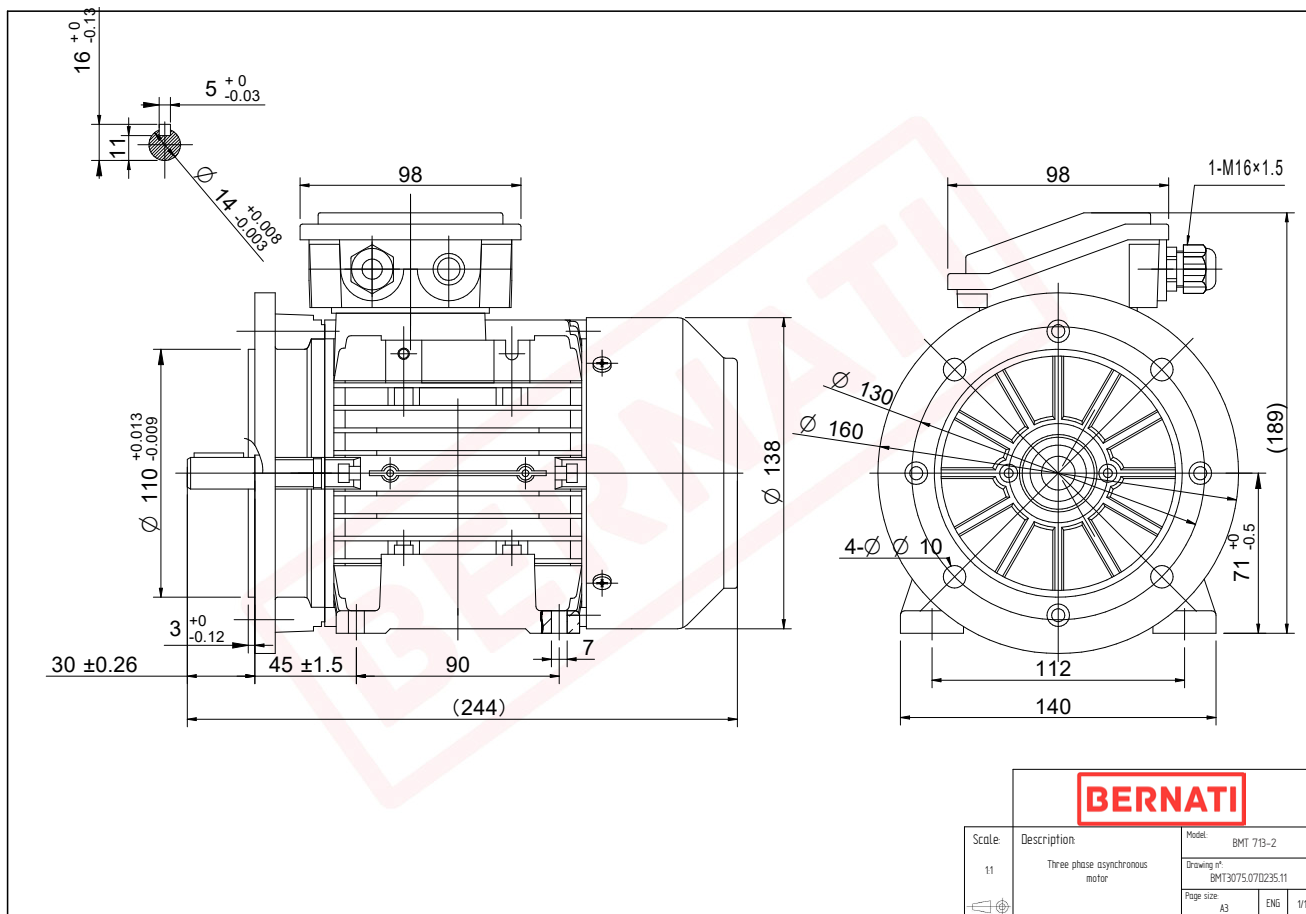

BMT	
Product Code	BMT3075.07D235.11
Motor Type/Frame	BMT 713-2
Mounting	IM B3/B5
Efficiency Class	IE3
Output Power (kW)	0.75
Speed (rpm)	2870
Tension (V)	230/400
Frequency (Hz)	50
Current (A)	1.64
Power factor (Cos Ø)	0.82
Poles	2
Insulation Class	F
IP Class	IP55
50% Efficiency	78.2
75% Efficiency	80.8
100% Efficiency	80.7
Torque (Nm)	2.50
Tstart / Tnominal	3.00
Istart / Inominal	7.10
Tmax / Tnominal	3.20
Noise (dB)	65
PTC Thermistor	PTC 130
Weight (Kg)	7
DE Bearing	6202 2RZ C3
NDE Bearing	6202 2RZ C3