

Technical Datasheet

BERNATI

BMT Series - Aluminum frame three phase low voltage electric motor

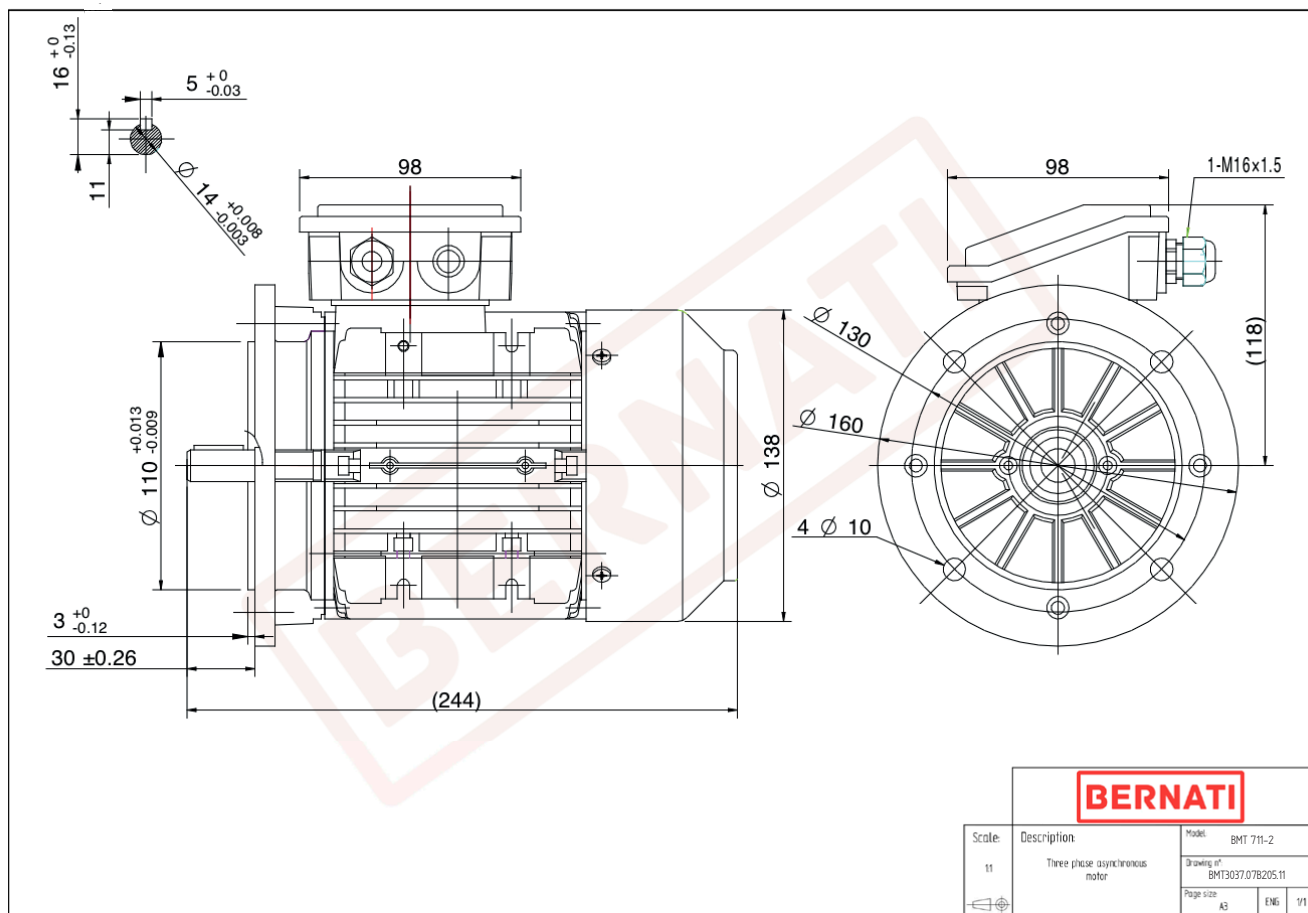

BMT

Product Code	BMT3037.07B205.11
Motor Type/Frame	BMT 711-2
Mounting	IM B5
Efficiency Class	IE3
Output Power (kW)	0.37
Speed (rpm)	2860
Tension (V)	230/400
Frequency (Hz)	50
Current (A)	0.95
Power factor (Cos Ø)	0.76
Poles	2
Insulation Class	F
IP Class	IP55
50% Efficiency	66.5
75% Efficiency	72.4
100% Efficiency	73.8
Torque (Nm)	1.24
Tstart / Tnominal	2.50
Istart / Inominal	5.60
Tmax / Tnominal	2.80
Noise (dB)	64
PTC Thermistor	PTC 130
Weight (Kg)	5
DE Bearing	6202 2RZ C3
NDE Bearing	6202 2RZ C3