

BMT Series - Aluminum frame three phase low voltage electric motor

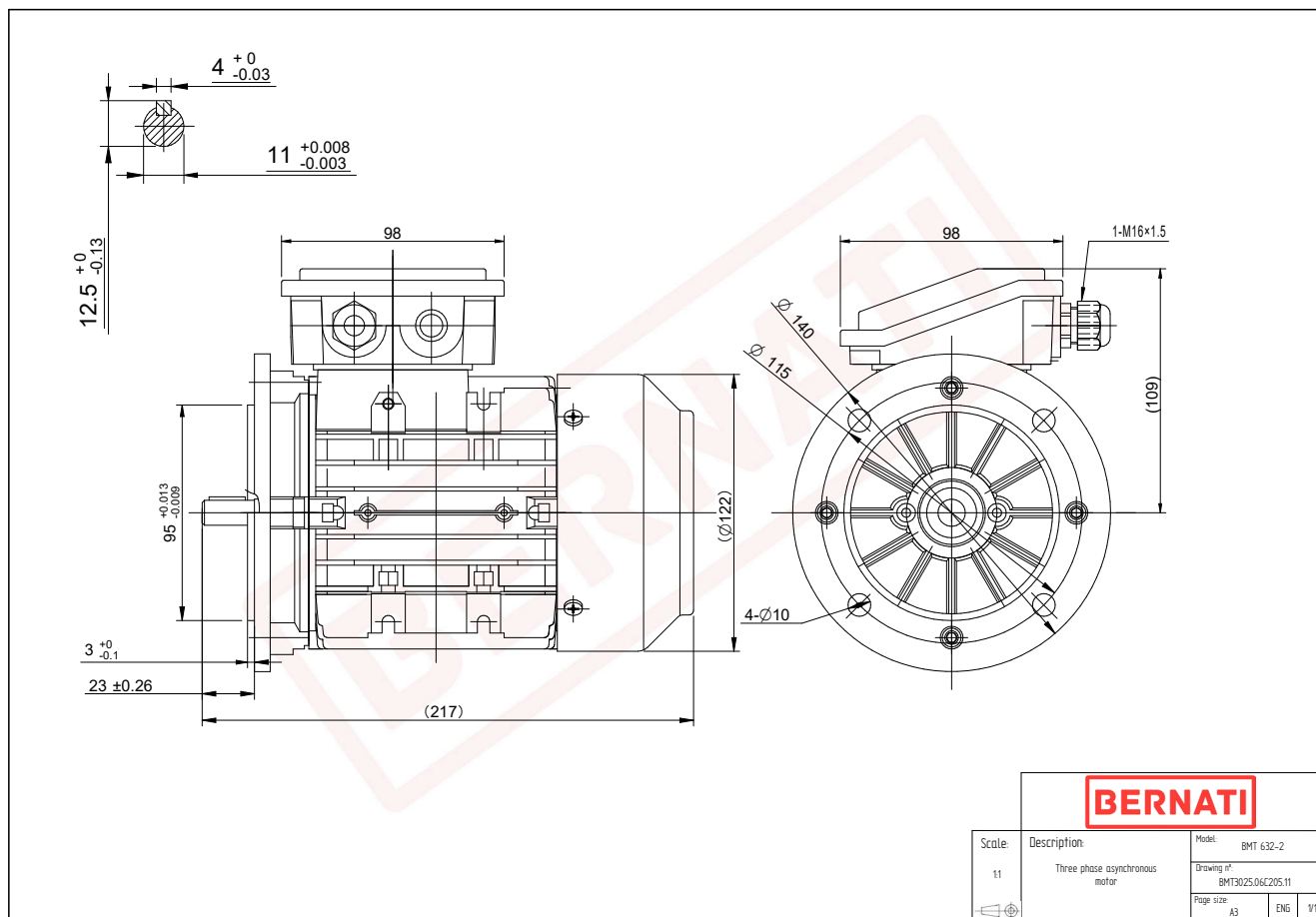

BMT

Product Code	BMT3025.06C205.11
Motor Type/Frame	BMT 632-2
Mounting	IM B5
Efficiency Class	IE3
Output Power (kW)	0.25
Speed (rpm)	2840
Tension (V)	230/400
Frequency (Hz)	50
Current (A)	0.66
Power factor (Cos Ø)	0.78
Poles	2
Insulation Class	F
IP Class	IP55
50% Efficiency	62.5
75% Efficiency	68.4
100% Efficiency	69.7
Torque (Nm)	0.84
Tstart / Tnominal	2.50
Istart / Inominal	5.20
Tmax / Tnominal	2.70
Noise (dB)	61
PTC Thermistor	PTC 130
Weight (Kg)	4
DE Bearing	6201 2RZ C3
NDE Bearing	6201 2RZ C3